



BUSINESS IS PERSONAL

Your desk phone can drive your digital transformation

ALE | Where Everything Connects

OXO Connect

8078s Premium DeskPhone

8068s Premium DeskPhone

8058s Premium DeskPhone

8028s Premium DeskPhone

8018 DeskPhone

8008 DeskPhone

User Manual

8AL90340ENACed01-1822

Introduction

Thank you for choosing an Alcatel-Lucent phone.



This model offers enhanced ergonomic features for more effective communication.

Your phone can be used in any business environment, from on-premise PBX, to cloud deployment on multiple platforms, such as Alcatel-Lucent Enterprise servers or third-party SIP telephony platforms.

This document describes the services offered by the following sets connected to an OXO Connect or OXO Connect Evolution system:

- Alcatel-Lucent 8078s Bluetooth® Premium DeskPhone (8078s BT).
- Alcatel-Lucent 8078s Premium DeskPhone (8078s).
- Alcatel-Lucent 8068s Bluetooth® Premium DeskPhone (8068s BT).
- Alcatel-Lucent 8068s Premium DeskPhone (8068s).
- Alcatel-Lucent 8058s Premium DeskPhone (8058s).
- Alcatel-Lucent 8028s Premium DeskPhone (8028s).
- Alcatel-Lucent 8018 DeskPhone (8018).
- Alcatel-Lucent 8008 DeskPhone (8008).

The label and icons displayed depend on the type and the skin of the set. The label is not displayed if the corresponding feature is not configured on your telephone system. Depending on the size of the display, some labels may be truncated. *All labels are displayed in color and are italicized.* This icon describes a succession of actions or labels you have to do or select: **➤**.

This icon describes the consequence of an action: **➤➤**.

Some features depend on the type of the set.

	8078s BT	8078s	8068s BT	8068s	8058s	8028s	8018	8008
IP Phone	●	●	●	●	●	●	●	●
Color screen	●	●	●	●	●			
Monochrome screen						●	●	●
Busy light logo on back shell	●	●	●	●	●			
Theme (skin)	●	●	●	●	●			
Bluetooth® handset	●		●					
Bluetooth® Smart Ready	●	●	●	●				
Compatible with Bluetooth® headset	●	●	●	●				
USB headset	●	●	●	●	●	●	●	
Jack headset	●	●	●	●	●	●		
RJ9 headset*								●
Two-port Gigabit Ethernet switch with Power Over Ethernet support	●	●	●	●	●	●	●	
Two-port Fast Ethernet switch with Power Over Ethernet support								●
Premium Add-on 10 keys modules			●	●	●	●		
Premium Smart display 14 keys module	●	●	●	●	●	●		
Premium add-on 40-key modules	●	●	●	●	●	●		
Audio services (hands-free, handset and headset)	●	●	●	●	●	●	●	●
ALE Enhanced HD audio	●	●	●	●	●			
Adjusting the contrast of the display						●	●	●
Ambient light sensor	●	●	●	●	●			
Agent set / Supervisor station	●	●	●	●				
Remote worker	●	●	●	●	●	●	●	●
SIP Business third party call server	●	●	●	●	●	●	●	●

*Use an adapter RJ9 to connect a jack or usb headset (3GV28177AA).

ALE Enhanced HD audio (Super Wideband audio):

Wideband audio, or HD voice, is high definition voice quality for telephony audio. The frequency range of audio signals uses a wider frequency spectrum to deliver high voice quality. This technology is implemented in our phones and is called 'ALE Enhanced HD audio'. Enjoy HD audio quality in hands-free mode with the handset 'ALE Wideband Bluetooth® Handset' or with a compatible Bluetooth® headset.

The labels and icons presented in this document are not contractually binding and may be modified without prior warning.

History of the document

8AL90340xxAC	<ul style="list-style-type: none">• 8008 DeskPhone.• New description of accessories: 8008 wall mount kit, USB external ringing interface module.• 8058s dual display mode.• 8018 DeskPhone.• Add list and description of accessories: 8115/8125 Audiooffice, External ringing interface module, Premium Wall mount kit, 8018 wall mount kit.• Add technical specifications.• Add ordering information.
8AL90340xxAA	<ul style="list-style-type: none">• 8078s,8068S,8058s,8028s Premium DeskPhone.

1	Getting to know your telephone	11
1.1	8078s Bluetooth/ 8078s Premium DeskPhone	11
1.1.1	Phone description	11
1.1.2	Main screen and navigation keys	11
1.1.3	Call management screen	12
1.1.4	Access to the user local menu	12
1.1.5	Change the theme (skin) of your phone	12
1.1.6	Busy light logo on back shell	13
1.1.7	Bluetooth Smart Ready	13
1.2	8068s Bluetooth/ 8068s Premium DeskPhone	14
1.2.1	Phone description	14
1.2.2	Main screen and navigation keys	14
1.2.3	Call management screen	15
1.2.4	Access to the user local menu	15
1.2.5	Change the theme (skin) of your phone	16
1.2.6	Busy light logo on back shell	16
1.2.7	Bluetooth Smart Ready	16
1.3	8058s Premium DeskPhone	17
1.3.1	Phone description	17
1.3.2	Dual display mode	17
1.3.3	Main screen and navigation keys	18
1.3.4	Call management screen	18
1.3.5	Access to the user local menu	19
1.3.6	Change the theme (skin) of your phone	19
1.3.7	Busy light logo on back shell	19
1.4	8028s Premium DeskPhone	20
1.4.1	Phone description	20
1.4.2	Main screen and navigation keys	20
1.4.3	Call management screen	21
1.4.4	Access to the user local menu	21
1.4.5	Changing or updating the paper label	21
1.5	8018 DeskPhone	22
1.5.1	Phone description	22
1.5.2	Main screen and navigation keys	22
1.5.3	Call management screen	23
1.5.4	Changing or updating the paper label	23
1.5.5	Function keys and programmable keys	23
1.6	8008 DeskPhone	24
1.6.1	Phone description	24
1.6.2	Main screen and navigation keys	24
1.6.3	Call management screen	25
1.6.4	Function keys and programmable keys	25
1.7	Welcome screens	26
1.7.1	Homepage description	26
1.8	User local menu	27
1.9	Status icons/ Call icons	28
1.10	Permanent features keys	29
1.11	Keyboard	30

1.11.1	Magnetic alphabetic keyboard (8078s, 8068s, 8058s, 8028s Premium DeskPhone)	30
1.11.2	Alpha-numeric keyboard (8008/8018 DeskPhone)	31
1.12	Description of the connectors	32
1.13	Add-on module	33
1.13.1	Install the add-on to the deskphone	33
1.13.2	Install more than one add-on module	34
1.13.3	Attach the add-on with the clip	34
1.13.4	Changing or updating the paper label	35
1.14	ALE Wideband Bluetooth® Handset	36
1.14.1	Voice prompts	37
1.14.2	Installing or replacing the Bluetooth® handset battery	37
1.14.3	Pairing and connecting the Bluetooth® wireless handset	37
1.15	ALE Bluetooth® Handset	38
1.15.1	LED	39
1.15.2	Installing or replacing the Bluetooth® handset battery	39
1.15.3	Pairing and connecting the Bluetooth® wireless handset	40
1.16	Install a comfort wired handset	40
2	Using your telephone	41
2.1	Identify the terminal you are on	41
2.2	Messaging portal	41
2.3	Consulting the call log	42
2.4	Making a call	44
2.5	Receiving a call	45
2.6	Switching between audio modes	46
2.7	Activating the loudspeaker during a conversation (handset lifted) -group listening feature	47
2.8	Making calls by name (company directory)	47
2.8.1	Calling a contact using the unified directory	47
2.8.2	Calling a contact using the internal directory (predictive search)	48
2.9	Make calls via your programmed call keys (Perso page/F1 and F2 keys/Add-on module)	48
2.10	Filtering calls using the voice mailbox	48
2.10.1	Activating call screening	48
2.10.2	When you receive a call	49
2.11	Redialing	49
2.11.1	Redialing the last number dialed (redial)	49
2.11.2	Call back on the last 10 numbers dialed	49
2.12	Requesting automatic callback if internal number is busy	49
2.13	Cancelling an automatic callback	49
2.14	Receiving interphony calls	50
2.15	Sending DTMF signals	50
2.16	Mute, so that your contact cannot hear you	50
2.16.1	From the set	50
2.16.2	From the Bluetooth® handset (Bluetooth® wireless handset)	50
2.16.3	From the headset	50
2.17	Forwarding calls to your voice message service	51
2.18	Consulting your voice mailbox	51
2.19	Sending an instant message to a contact	52
2.19.1	Sending an instant message using the search by name feature	52
2.19.2	Sending an instant message using the phone number	52

2.19.3	Status of the instant messages	53
2.20	Consulting instant messages	53
2.21	Answering with an instant message	54
2.21.1	Answering an Instant message	54
2.21.2	Answering a voice message	54
2.21.3	Answering from the call log	55
2.22	Lock / unlock your telephone	55
3	During a conversation	56
3.1	Making a second call during a conversation	56
3.1.1	Recover the call on hold	56
3.2	Answering a second call during a conversation	56
3.3	Switching between calls (Broker call)	57
3.4	Transferring a call	57
3.5	Transfer a call to a voice mail	57
3.6	Three-way conference with internal and/or external contacts (conference)	57
3.6.1	Cancel the conference and recover the last active call before the conference (the other is on hold) (If conference is active)	57
3.6.2	End the conference with all participants (If conference is active)	57
3.6.3	After the conference, to leave your two contacts talking together:	58
3.7	Placing a call on hold (hold)	58
3.8	Placing an outside call on hold (parking)	58
3.9	Intrusion into an internal conversation (barge-in)	58
3.9.1	Protection against intrusion	58
3.10	Save a number into your personal directory	58
4	'Meet me' conference	59
4.1	Initiate a 'Meet me' conference	59
4.2	Join a 'Meet me' conference	59
5	Sharing	60
5.1	Receiving supervised call ringing	60
5.2	Answering the general bell	60
5.3	Manager/Assistant filtering	60
5.3.1	From the manager or assistant telephone	60
5.4	Call pick-up	60
5.4.1	If the telephone ringing is in your own pick-up group	60
5.4.2	If the telephone ringing is not in your pick-up group	60
5.5	Answering briefly in place of the operator	61
5.6	Hunting groups	61
5.6.1	Hunting group call:	61
5.6.2	Temporary exit from your hunting group:/Return into your group:	61
5.7	Calling an internal contact on his/her pager	61
5.8	Answering a call on your pager	61
5.9	Calling a contact on his/her loudspeaker	62
5.10	Send a voice message copy	62
5.11	Sending a recorded message to a number or a distribution list	62
5.12	Broadcasting a message on the loudspeakers of a station group	63

6	Keep in touch	64
6.1	Selecting calls to be forwarded	64
6.2	Forwarding calls to another number (immediate forward)	64
6.3	Personal assistant: reaching you with one number only	64
6.4	Activate/disable the personal assistant	64
6.5	Forwarding your calls from the receiving terminal ('Follow me')	65
6.6	Diverting all group calls	65
6.7	Cancelling all forwards	65
6.8	Cancelling a specific forward	65
6.9	Forwarding calls when your line is busy (forward if busy)	65
6.10	Do not disturb	66
6.11	Leaving a text message for internal callers	66
6.12	Message notification	67
6.12.1	Change the time slot	67
6.13	Forwarding calls to your pager	67
7	Programming your telephone	68
7.1	Initializing your voice mailbox	68
7.2	Customizing your voice greeting	68
7.3	Modifying your personal code	68
7.4	Adjusting the audio functions	69
7.4.1	Choose the tune	69
7.4.2	Adjusting the ringer volume	69
7.4.3	Activate/deactivate silent mode	69
7.4.4	Activate/deactivate meeting mode (progressive ringing)	69
7.4.5	Activate/deactivate discreet ring mode	69
7.4.6	Adjust ringer volume while a call arrives	69
7.5	Adjusting the brightness of the deskphone (8078s, 8068s, 8058s, 8028s Premium DeskPhone)	70
7.5.1	Auto-adjusting of the brightness	70
7.5.2	Adjust the brightness when the phone is in use	70
7.5.3	Adjust the dimmed brightness when the phone is not in use	70
7.5.4	Set the delay before the brightness is dimmed when the phone is not in use (screensaver)	70
7.6	Adjusting the contrast of the display (8028s, 8018, 8008)	71
7.7	Selecting the welcome page	71
7.8	Selecting language	71
7.9	Programming direct call keys (Perso page/F1 and F2 keys/Add-on module)	71
7.10	Modifying direct call keys	72
7.11	Deleting direct call keys	72
7.12	Programming an appointment reminder	72
7.13	Install a jack accessory (headset, hands-free, loudspeaker) (8078s, 8068s, 8058s, 8028s Premium DeskPhone)	73
7.14	Install a USB accessory (Headset, Handsfree, Loudspeaker)	73
7.15	Manage connected devices	74
7.15.1	List of connected devices	74
7.15.2	Default device	74
7.16	Activating/Deactivating 'Forced headset' mode	74
7.17	Installing and using an ALE Bluetooth® wireless handset	74
7.18	Installing a Bluetooth® Wireless Technology headset (pairing)	75

7.19	Using a Bluetooth® Wireless Technology headset	75
7.20	Display all paired Bluetooth® devices	76
7.21	Removing a Bluetooth® accessory (headset, handset, etc.)	76
7.22	Pair your phone as a Bluetooth® device	76
7.23	Configure your phone for teleworking	77
7.23.1	First connection as teleworking	77
7.23.2	Change the configuration	78
7.23.3	PIN code	79
7.23.4	Reset your PIN code	79
7.23.5	Reconnect your deskphone in your business place	79
7.23.6	Reconnect your deskphone in remote place	80
8	Contacting your administrator (Technical support)	81
8.1.1	Date code (right) / Technical code (left)	81
8.1.2	Software version	82
8.2	Hardware model	82
8.3	Phone auto test	82
9	ACD: Agent set/ Supervisor station	83
9.1	Agent set	83
9.2	Open an agent session (login) – Agent set	83
9.3	ACD application welcome screen – Agent set	83
9.4	The four operating statuses of the agent set	84
9.5	Changing the operating status of the set – Agent set	84
9.5.1	Changing using codes (all sets)	84
9.5.2	Change using function keys	84
9.6	Modifying your personal code – Agent set	84
9.7	Integrating another group/leaving a group – Agent set	84
9.8	Close the agent session (logout) – Agent set	84
9.9	Supervisor station	84
9.10	Supervising group mailboxes – Supervisor station	85
9.10.1	Consulting the messages:-	85
9.10.2	Supervision keys for group mailboxes and positioning on the sets:-	85
10	Accessories	86
10.1	List of accessories	86
10.1.1	Jack 3.5 mm 4-pole corded headset	86
10.1.2	USB headset	86
10.1.3	Bluetooth® headset	86
10.1.4	Adapter	86
10.1.5	Conference module	86
10.1.6	EHS interface	86
10.1.7	Other accessories (headsets)	86
10.2	8115/8125 Audiooffice	87
10.2.1	Box content	87
10.2.2	Description	88
10.2.3	Set-up	88
10.2.4	Connect your devices	89
10.2.5	Bluetooth®(8125 Audiooffice)	89
10.2.6	Use your device	90

10.2.7	Use the 8125 Audiooffice with your mobile	91
10.3	USB external ringing interface module (USB Interface module 2 relays 3GV28184AA)	92
10.3.1	Installation	92
10.3.2	Connect the device	93
10.4	External ringing interface module (MWS 3GV28050AA)	94
10.4.1	List of supplies	94
10.4.2	Installation	94
10.4.3	Connect the device	95
10.5	Wall mounting kit	96
10.5.1	8068s, 8058s, 8028s Premium DeskPhone	96
10.5.2	8018 DeskPhone	97
10.5.3	8008 DeskPhone	98
10.6	Connect a 3 pole jack headset	99
10.7	Alcatel-Lucent Enterprise Application Partner Program	100
11	Technical specifications	101
12	Ordering information	104
13	Guarantee and clauses	105
13.1	Safety Instructions	105
13.2	Regulatory Statements	106

1 Getting to know your telephone

1.1 8078s Bluetooth/ 8078s Premium DeskPhone

This phone is part of the IP phone range. With its 5 inches touch color display, the 8078s Premium DeskPhone delivers a great user experience and a great conversation comfort with an outstanding wideband audio quality either in hands-free or using the comfort handset. Additionally, the 8078s Bluetooth® Premium DeskPhone improves your experience with its Bluetooth® handset or other Bluetooth® accessories. The 8078s Bluetooth® Premium DeskPhone is 'Bluetooth® Smart Ready'. You can personalize the phone by selecting a theme (skin). It is compatible with teleworking. Consequently, it is perfect for use at your office in your enterprise or at home (teleworking).

1.1.1 Phone description



- 1** LED
Flashing blue: incoming call / Appointment alarm.
- 2** Color touchscreen display with auto brightness adjustment which improves the user experience and achieves power savings (ambient light sensor).
- 3** Permanent feature keys: quick access to the phone's main features.
- 4** Bluetooth® wireless handset (8078s BT).
Wired handset.
- 5** 3.5 mm, 4 pole jack (TRRS standards: CTIA).
- 6** Magnetic alphabetic keyboard.
- 7** An adjustable and stable foot.
- 8** Wideband loudspeaker for optimized sound.

1.1.2 Main screen and navigation keys

Top bar (date, time, status icons)



Display the page by selecting the corresponding tab.

Navigation softkeys and quick access to specific settings

Forward icon.

Softkeys: Menus and actions available depending on the selected page.

- Select a page by pressing the corresponding tab on the screen. The selected page is highlighted.
Make your selection by pressing the label on the screen.
- Scroll a list (features, call log, contact, ...) by pressing the up and down arrow on the screen, or on the keyboard.
- Manage your call forwarding by pressing the forward icon.
 - Stationary arrow: No forwarding activated.
 - Blinking or rotating arrow according to the skin: Forwarding activated.
- Use the 'OK' softkey to validate your choices and options while programming or configuring.

-  Use the 'Back/Exit' icon to go back to the previous step.
-  Use the 'Setting' icon for quick access to the user local menu.
-  Use the 'Bluetooth®' icon to open Bluetooth® settings.



1.1.3 Call management screen

Tabs: Incoming call icon, Call in progress, Call on hold, ...

Notification (popup) of incoming call





Softkeys: actions available depending on the call status (when presentation screen is not displayed)



-  Each tab corresponds to a call, the status of which is symbolized by its icon (in progress, call on hold, arrival of new call). When a call is in progress, press on the corresponding tab to look at calls on hold or incoming calls.
-  All features are accessible while the call is displayed on the screen. Use the Up and Down arrows to move up or down a page. These functions (transfer, conference, etc.) are directly related to the status of the call consulted. For example, the transfer function will not be available between a call in progress or on hold and an incoming call.
-  Use to switch to the main screen during conversation to access some functions, for example, searching by name.

Calls can also be managed from the Perso page. While the call is in progress, press the Back/Exit key and display the Perso page. Calls in progress or waiting calls are displayed on the different line keys. It is then possible to converse with the contact of your choice by pressing the key associated to the contact.

1.1.4 Access to the user local menu

 or  (long press): Open the user local menu: *Audio, Display, Bluetooth®, Skin, About* (see: User local menu).

1.1.5 Change the theme (skin) of your phone

- The phone is in idle state.
-  or  (long press) ▶ *Skin*
- Select the desired new theme from the list (Classical, Rainbow, Green, Luxury, Release, Arcturus). Some skins (Arcturus) depend on the release of the phone. The pictures are given as an example.
- 

Changing the theme may take a few seconds. A corporate theme can be installed by your administrator. In this case, you cannot change the theme. The ringtone settings can be integrated into a theme.

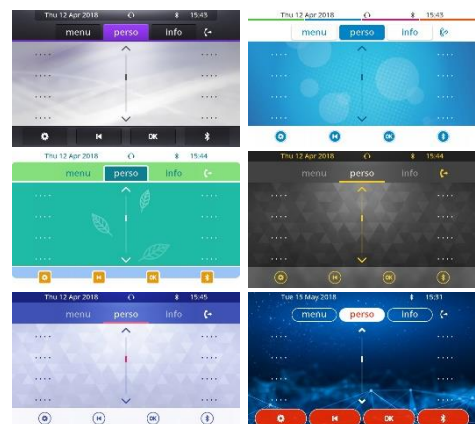

1.1.6 Busy light logo on back shell

The logo on back shell can be illuminated. The color changes when you are busy.

- The phone is in idle state.
-  or  (long press) › *Display* › *Advanced* › *Busy light*
- Activate or deactivate the logo LED feature.
- 



1.1.7 Bluetooth Smart Ready



Your phone is 'Bluetooth® Smart Ready'. It can receive and share Bluetooth® signals from various Bluetooth® devices (Bluetooth® and Bluetooth® Smart or Low-energy devices). Use your phone as a Bluetooth® speaker phone, as a conferencing module in your desktop. It is ready for future services available on the fly in a subsequent software upgrade. This feature can be deactivated by the administrator.

1.2 8068s Bluetooth/ 8068s Premium DeskPhone

This phone is part of the IP phone range. With its color display associated to 10 dedicated functions keys, and an intuitive navigation key, the 8068s Premium DeskPhone delivers a great user experience and great conversation convenience with an outstanding audio quality in either hands-free mode or using the comfort handset. Additionally, the 8068s Bluetooth® Premium DeskPhone improves your experience with its Bluetooth® handset or other Bluetooth® accessories. The 8068s Bluetooth® Premium DeskPhone is 'Bluetooth® Smart Ready'. You can personalize the phone by selecting a theme (skin). It is compatible with teleworking. Consequently, it is perfect for use at your office in your enterprise or at home (teleworking).

1.2.1 Phone description



- 1** LED
Flashing blue: incoming call / Appointment alarm.
Color display with auto brightness adjustment which enhances user experience and saves power (ambient light sensor).
- 2** 10 dedicated functions keys.
- 3** Navigation.
- 4** Permanent feature keys: quick access to the phone's main features.
- 5** Bluetooth® wireless handset (8068s BT).
Wired handset.
- 6** 3.5 mm, 4 pole jack (TRRS standards: CTIA).
- 7** Magnetic alphabetic keyboard.
- 8** An adjustable and stable foot.
- 9** Wideband loudspeaker for optimized sound.

1.2.2 Main screen and navigation keys

Top bar (date, time, status icons)

Display the page by selecting the corresponding tab.

Forward icon.

Softkeys: Menus and actions available depending on the selected page.



OK key: Use this key to validate your choices and options while programming or configuring.

Left-right navigator: In idle state, use this key to move from one page to another. In conversation, use this key to move between tabs of current calls (call in progress, calls on hold, incoming call). In the text edition, use this key to navigate into the text box.



Up-down navigator: Used to scroll through the content of a page.



Back/Exit key: Use this key to go back to the previous step. Use this key to go back to the homepage (long press).



Manage your call forwarding by pressing the key associated with the forward icon.

-  Stationary arrow: No forwarding activated.
-  Blinking or rotating arrow according to the skin: Forwarding activated.

1.2.3 Call management screen



Each tab corresponds to a call, the status of which is symbolized by its icon (in progress, call on hold, arrival of new call). When a call is in progress, use the left-right navigator to look at calls on hold or incoming calls.



All features are accessible while the call is displayed on the screen. Use the Up and Down arrows to move up or down a page. These functions (transfer, conference, etc.) are directly related to the status of the call consulted. For example, the transfer function will not be available between a call in progress or on hold and an incoming call.



Use to switch to the main screen during conversation to access some functions, for example, searching by name.



Press the key in front of the label to select the corresponding feature.

Calls can also be managed from the Perso page.



While the call is in progress, press the Back/Exit key and display the Perso page. Calls in progress or waiting calls are displayed on the different line keys. It is then possible to converse with the contact of your choice by pressing the key associated to the contact.

1.2.4 Access to the user local menu



(long press) ▶ Open the user local menu: *Audio, Display, Bluetooth®, Skin, About* (see: User local menu).

1.2.5 Change the theme (skin) of your phone

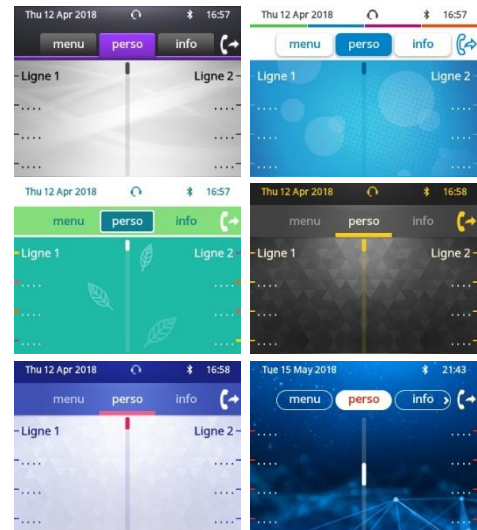

- The phone is in idle state.
-  (long press) > *Skin*
- Select the desired new theme from the list (Classical, Rainbow, Green, Luxury, Release, Arcturus). Some skins (Arcturus) depend on the release of the phone. The pictures are given as an example.
- 

Changing the theme may take a few seconds. A corporate theme can be installed by your administrator. In this case, you cannot change the theme. The ringtone settings can be integrated into a theme.



1.2.6 Busy light logo on back shell

The logo on back shell can be illuminated. The color changes when you are busy.

- The phone is in idle state.
-  (long press) > *Display* > *Advanced* > *Busy light*
- Activate or deactivate the logo LED feature.
- 



1.2.7 Bluetooth Smart Ready



You phone is 'Bluetooth® Smart Ready'. It can receive and share Bluetooth® signals from various Bluetooth® devices (Bluetooth® and Bluetooth® Smart or Low-energy devices). Use your phone as a Bluetooth® speaker phone, as a conferencing module in your desktop. It is ready for future services available on the fly in a subsequent software upgrade. This feature can be deactivated by the administrator.

1.3 8058s Premium DeskPhone

This phone is part of the IP phone range. In addition to a color display associated to 6 dedicated function keys and an intuitive navigation key, the 8058s Premium DeskPhone provides 4 programmable softkeys as a smart add-on module, for a quick access to your favorite contacts or features. It provides high audio fidelity for telephone calls either in hands-free mode or using the comfort handset. You can personalize the phone by selecting a theme (skin). It is compatible with teleworking. Consequently, it is perfect for use at your office in your enterprise or at home (teleworking).

1.3.1 Phone description



- 1** LED
Flashing blue: incoming call / Appointment alarm.
- 2** Color display with auto brightness adjustment which enhances user experience and saves power (ambient light sensor).
- 3** 6 dedicated functions keys.
- 4** virtual add-on: 4 programmable softkeys with LED (optional).
- 5** Navigation.
- 6** Permanent feature keys: quick access to the phone's main features.
- 7** Wired handset.
- 8** 3.5 mm, 4 pole jack (TRRS standards: CTIA).
- 9** Magnetic alphabetic keyboard.
- 10** An adjustable and stable foot.
- 11** Wideband loudspeaker for optimized sound.

The virtual add-on is optional and depends on the display mode defined by your administrator. Contact your administrator for more information.

1.3.2 Dual display mode

The 8058s Premium DeskPhone offers a dual display mode. Your administrator defines the display mode of your deskphone. Contact your administrator for more information.



User interface with virtual add-on. 4 programmable softkeys are displayed and can be used as a smart add-on module.



User interface without virtual add-on.

1.3.3 Main screen and navigation keys

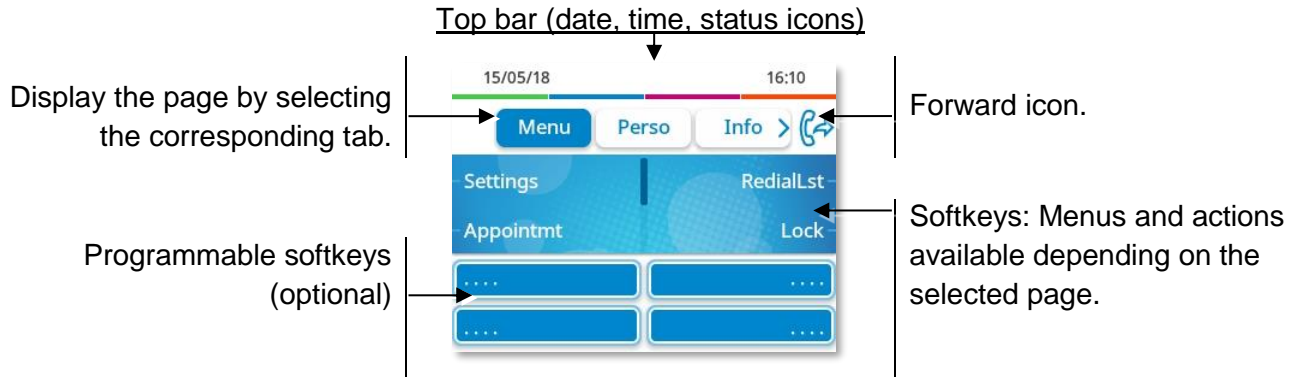

OK key: Use this key to validate your choices and options while programming or configuring.
Left-right navigator: In idle state, use this key to move from one page to another. In conversation, use this key to move between tabs of current calls (call in progress, calls on hold, incoming call). In the text edition, use this key to navigate into the text box.
Up-down navigator: Used to scroll through the content of a page.



Back/Exit key: Use this key to go back to the previous step. Use this key to go back to the homepage (long press).



Manage your call forwarding by pressing the key associated with the forward icon.

- Stationary arrow: No forwarding activated.
- Blinking or rotating arrow according to the skin: Forwarding activated.

1.3.4 Call management screen

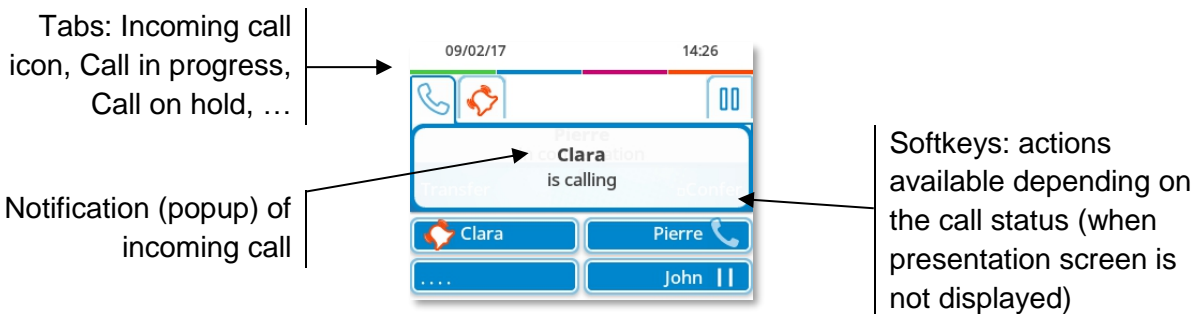

Each tab corresponds to a call, the status of which is symbolized by its icon (in progress, call on hold, arrival of new call). When a call is in progress, use the left-right navigator to look at calls on hold or incoming calls.



All features are accessible while the call is displayed on the screen. Use the Up and Down arrows to move up or down a page. These functions (transfer, conference, etc.) are directly related to the status of the call consulted. For example, the transfer function will not be available between a call in progress or on hold and an incoming call.



Use to switch to the main screen during conversation to access some functions, for example, searching by name.



Press the key in front of the label to select the corresponding feature.



Calls can also be managed from the Perso page.

While the call is in progress, press the Back/Exit key and display the Perso page. Calls in progress or waiting calls are displayed on the different line keys. It is then possible to converse with the contact of your choice by pressing the key associated to the contact.

1.3.5 Access to the user local menu

 (long press) › Open the user local menu: *Audio, Display, Skin, About* (see: User local menu).

1.3.6 Change the theme (skin) of your phone

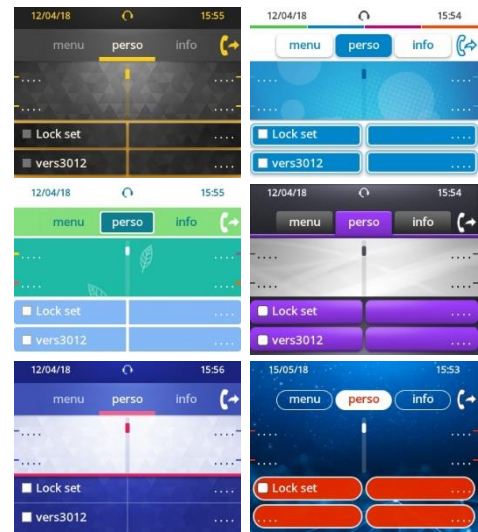

- The phone is in idle state.
-  (long press) › *Skin*
- Select the desired new theme from the list (Classical, Rainbow, Green, Luxury, Release, Arcturus). Some skins (Arcturus) depend on the release of the phone. The pictures are given as an example.
- 

Changing the theme may take a few seconds. A corporate theme can be installed by your administrator. In this case, you cannot change the theme. The ringtone settings can be integrated into a theme.



1.3.7 Busy light logo on back shell

The logo on back shell can be illuminated. The color changes when you are busy.

- The phone is in idle state.
-  (long press) › *Display* › *Advanced* › *Busy light*
- Activate or deactivate the logo LED feature.
- 



1.4 8028s Premium DeskPhone

This phone is part of the IP phone range. In addition to a clear monochrome display associated to 6 dedicated function keys and an intuitive navigation key, the 8028s Premium DeskPhone provides 4 programmable keys as a smart add-on module, for a quick access to your favorite contacts or features. It provides high audio fidelity for telephone calls either in hands-free mode or using the comfort handset. It is compatible with teleworking. Consequently, it is perfect for use at your office in your enterprise or at home (teleworking).







1.4.1 Phone description

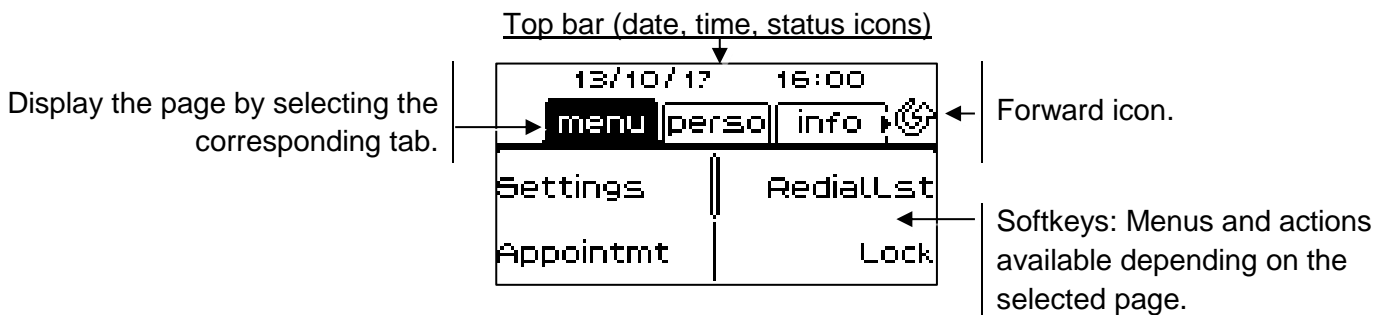

- 1** LED
Flashing blue: incoming call / Appointment alarm.
- 2** Monochrome backlit screen.
- 3** 6 dedicated functions keys.
- 4** 4 programmable keys with Led and paper label.
- 5** Navigation.
- 6** Permanent feature keys: quick access to the phone's main features.
- 7** Wired handset.
- 8** 3.5 mm, 4 pole jack (TRRS standards: CTIA).
- 9** Magnetic alphabetic keyboard.
- 10** An adjustable and stable foot.
- 11** Loudspeaker.





1.4.2 Main screen and navigation keys

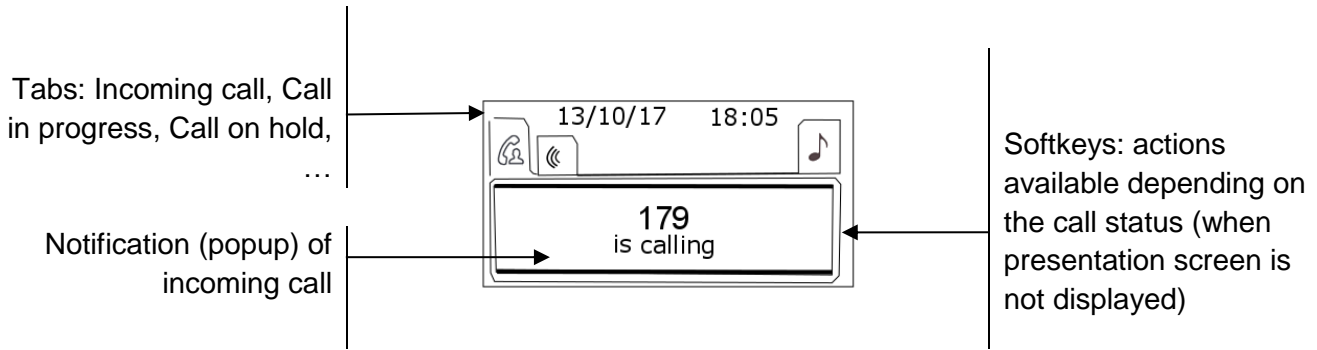

-  **OK key:** Use this key to validate your choices and options while programming or configuring.
-  **Left-right navigator:** In idle state, use this key to move from one page to another. In conversation, use this key to move between tabs of current calls (call in progress, calls on hold, incoming call). In the text edition, use this key to navigate into the text box.
-  **Up-down navigator:** Used to scroll through the content of a page.
-  **Back/Exit key:** Use this key to go back to the previous step. Use this key to go back to the homepage (long press).
-  Manage your call forwarding by pressing the key associated with the forward icon.
 -  Stationary white icon: No forwarding activated.
 -  Blinking or rotating arrow according to the skin: Forwarding activated.

1.4.3 Call management screen



	Each tab corresponds to a call, the status of which is symbolized by its icon (in progress, call on hold, arrival of new call). When a call is in progress, use the left-right navigator to look at calls on hold or incoming calls.
	All features are accessible while the call is displayed on the screen. Use the Up and Down arrows to move up or down a page. These functions (transfer, conference, etc.) are directly related to the status of the call consulted. For example, the transfer function will not be available between a call in progress or on hold and an incoming call.
	Use to switch to the main screen during conversation to access some functions, for example, searching by name.
	Press the key in front of the label to select the corresponding feature.

1.4.4 Access to the user local menu

 (long press) › Open the user local menu: *Audio, Display* (see:User local menu).

1.4.5 Changing or updating the paper label

Removing the paper label

- Lift the protective cover at the notch (1).
- Remove the paper label in the same way (2).
- Update or replace the paper label.

Inserting the phone label

- Position the phone label, left side first, making sure it is placed correctly behind the notches (a,b,c,d).
- Put the protective cover back in the same way.

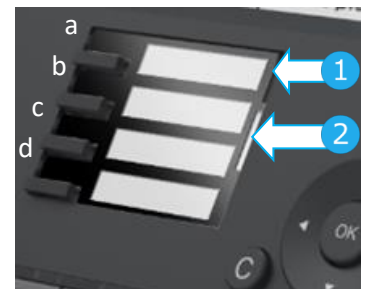

The application 'LabelSet' is available to help you to print the paper labels. Please contact your business partner for more information.

1.5 8018 DeskPhone

This phone is part of the IP phone range. In addition to a clear monochrome display associated to 6 dedicated function keys and an intuitive navigation key, the 8018 DeskPhone provides 4 programmable keys as a smart add-on module, for a quick access to your favorite contacts or features. It provides high audio fidelity for telephone calls either in hands-free mode or using the comfort handset. It is compatible with teleworking. Consequently, it is perfect for use at your office in your enterprise or at home (teleworking).

1.5.1 Phone description



- 1 LED
Flashing blue: incoming call / Appointment alarm.
- 2 Monochrome screen.
- 3 6 dedicated functions keys.
- 4 3 preprogrammed keys with Led and paper icon: Alpha-numeric key, F1, F2.
4 programmable keys with Led and paper label.
- 5 Navigation.
- 6 Permanent feature keys: quick access to the phone's main features.
- 7 Wired handset.
- 8 USB connector for headset.
- 9 Stable foot
- 10 Loudspeaker.

Your phone has 4 programmable keys with led and paper label. These keys are used to program a direct call. You can use the paper to describe the key.

1.5.2 Main screen and navigation keys

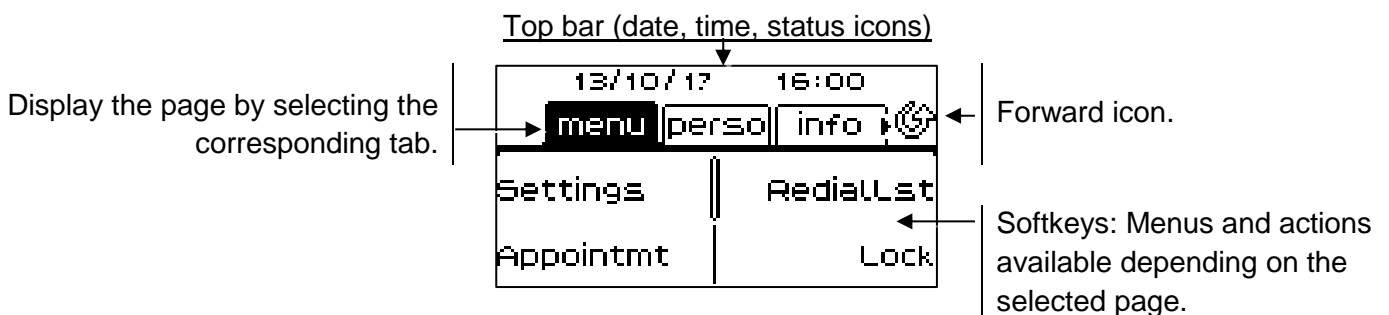

OK key: Use this key to validate your choices and options while programming or configuring.
Left-right navigator: In idle state, use this key to move from one page to another. In conversation, use this key to move between tabs of current calls (call in progress, calls on hold, incoming call). In the text edition, use this key to navigate into the text box.
Up-down navigator: Used to scroll through the content of a page.



Back/Exit key: Use this key to go back to the previous step. Use this key to go back to the homepage (long press). Use this key to delete one number or character at a time.







Manage your call forwarding by pressing the key associated with the forward icon.

- Stationary white icon: No forwarding activated.
- Blinking or rotating arrow according to the skin: Forwarding activated.

1.5.3 Call management screen



-  Each tab corresponds to a call, the status of which is symbolized by its icon (in progress, call on hold, arrival of new call). When a call is in progress, use the left-right navigator to look at calls on hold or incoming calls.
-  All features are accessible while the call is displayed on the screen. Use the Up and Down arrows to move up or down a page. These functions (transfer, conference, etc.) are directly related to the status of the call consulted. For example, the transfer function will not be available between a call in progress or on hold and an incoming call.
-  Use to switch to the main screen during conversation to access some functions, for example, searching by name.
-  Press the key in front of the label to select the corresponding feature.

Calls can also be managed from the Perso page.

While the call is in progress, press the Back/Exit key and display the Perso page. Calls in progress or waiting calls are displayed on the different line keys. It is then possible to converse with the contact of your choice by pressing the key associated to the contact.

1.5.4 Changing or updating the paper label

Removing the paper label

- Lift the protective cover at the notch and slide it up to take it out of its housing.
- Remove the paper label in the same way.
- Update or replace the paper label.

Inserting the phone label

- Insert the paper label from the top end, making sure it is placed correctly behind the notches.
- Put the protective cover back in the same way.



The application 'LabelSet' is available to help you to print the paper labels. Please contact your business partner for more information.

1.5.5 Function keys and programmable keys



The 8018 DeskPhone uses 3 preprogrammed keys to access some features. In this case, the icon of the feature is printed on the paper. Use the feature by pressing the corresponding key. When activated, the LED corresponding to the key remains lit up. Press the corresponding key to deactivate it.

- **123<->abc** Alpha-numerical keypad
Use this key to switch between alphabetic keyboard and numeric keyboard.
- **F** Programmable keys (F1 and F2 keys). A service or a direct call can be associated to these keys.

1.6 8008 DeskPhone

This phone is part of the IP phone range. In addition to a clear monochrome display with six dedicated function keys and an intuitive navigation key, the 8008 DeskPhone provides high audio fidelity for telephone calls either in hands-free mode or using the comfortable handset. It is compatible with teleworking. Consequently, it is perfect for use at your office in your enterprise or at home (teleworking).

1.6.1 Phone description



- 1 Monochrome screen.
- 2 LED
Flashing blue: incoming call / Appointment alarm.
- 3 6 dedicated functions keys.
- 4 Navigation, ok and cancel keys.
- 5 3 preprogrammed keys with LEDs: Alpha-numeric key, F1, F2.
- 6 Messaging key to access various mail services.
- 7 Mute and interphony key.
- 8 Audio feature keys.
- 9 Redial key.
- 10 Loudspeaker.
- 11 Wired handset.
- 12 Stable foot.

A corded headset can be connected via RJ9 connector (see: Description of the connectors). Use an adapter RJ9 to connect a jack or usb headset (3GV28177AA).

1.6.2 Main screen and navigation keys

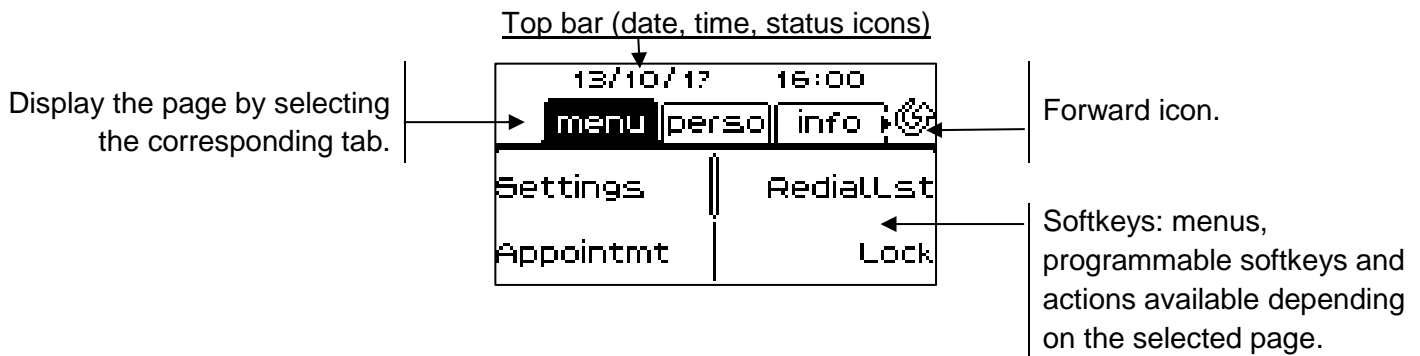

OK key: Use this key to validate your choices and options while programming or configuring.

Left-right navigator: In idle state, use this key to move from one page to another. In conversation, use this key to move between tabs of current calls (call in progress, calls on hold, incoming call). In the text edition, use this key to navigate into the text box.

Up-down navigator: Used to scroll through the content of a page.



Back/Exit key: Use this key to go back to the previous step. Use this key to go back to the homepage (long press). Use this key to delete one number or character at a time.



Manage your call forwarding by pressing the key associated with the forward icon.

- Stationary white icon: No forwarding activated.
- Blinking or rotating arrow according to the skin: Forwarding activated.

1.6.3 Call management screen

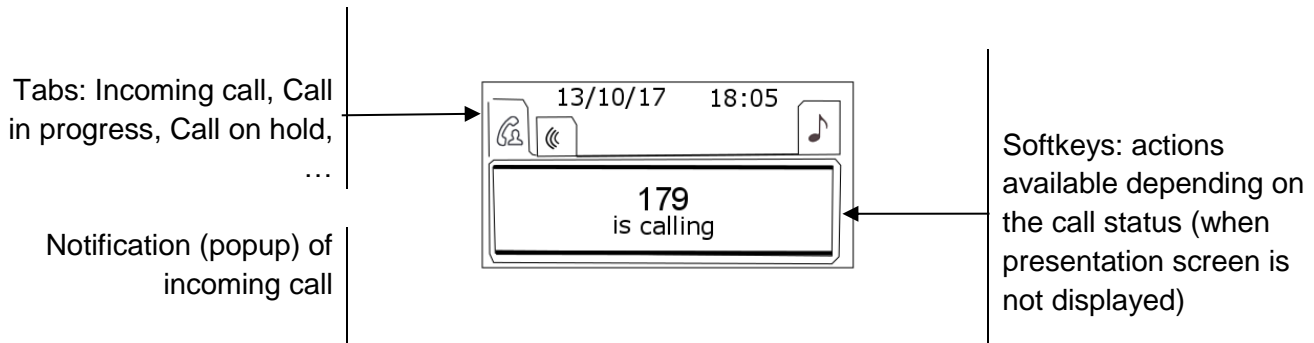

Each tab corresponds to a call, the status of which is symbolized by its icon (in progress, call on hold, arrival of new call). When a call is in progress, use the left-right navigator to look at calls on hold or incoming calls.



All features are accessible while the call is displayed on the screen. Use the Up and Down arrows to move up or down a page. These functions (transfer, conference, etc.) are directly related to the status of the call consulted. For example, the transfer function will not be available between a call in progress or on hold and an incoming call.



Use to switch to the main screen during conversation to access some functions, for example, searching by name.



Press the key in front of the label to select the corresponding feature.

Calls can also be managed from the Perso page.

While the call is in progress, press the Back/Exit key and display the Perso page. Calls in progress or waiting calls are displayed on the different line keys. It is then possible to converse with the contact of your choice by pressing the key associated to the contact.

1.6.4 Function keys and programmable keys



The 8008 DeskPhone uses 3 preprogrammed keys to access some features. In this case, the icon of the feature is printed on the paper. Use the feature by pressing the corresponding key. When activated, the LED corresponding to the key remains lit up. Press the corresponding key to deactivate it.

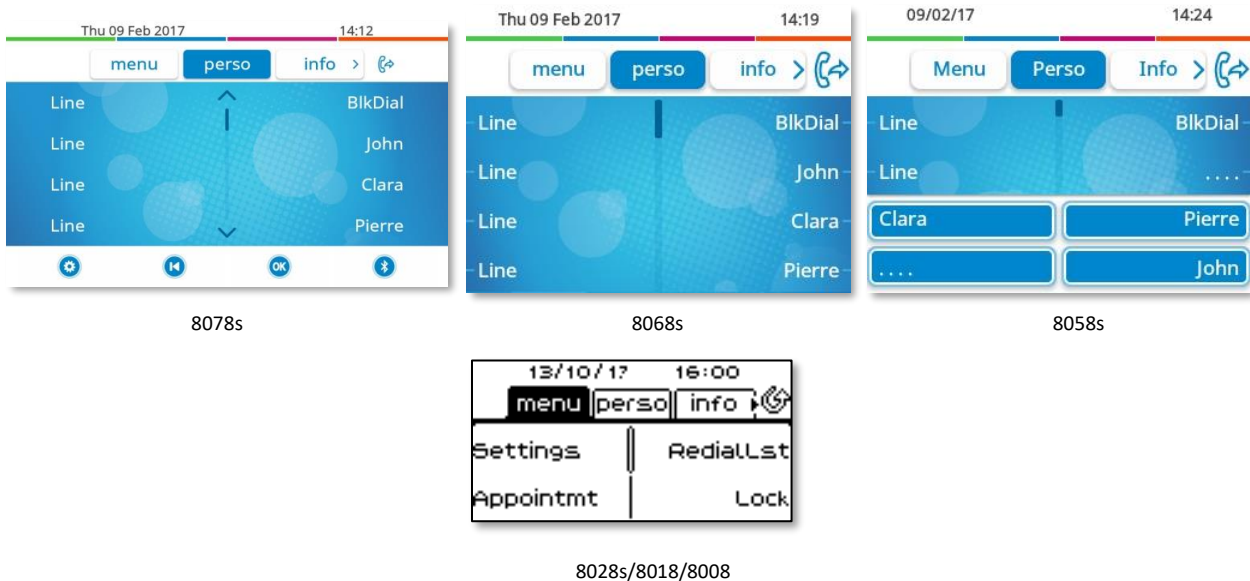

- Alpha-numerical keypad
Use this key to switch between alphabetic keyboard and numeric keyboard.
- Programmable keys (F1 and F2 keys). A service or a direct call can be associated to these keys.

1.7 Welcome screens



1.7.1 Homepage description

You can access all of your phone's features from these screens. The default display has three pages that you can access by pressing to the page tabs at the top of the screen. The selected page is highlighted. The default pages can be augmented with other applications (ACD for example) installed and/or configured on your system.



- Menu page *Menu*
Contains all features and applications accessible by pressing the label of the desired feature or application. From this page, it is possible to adjust the ringer volume, program the time of an appointment, lock the terminal, define the default page displayed, configure voice mail, and access telephone functions such as calling back one of the last numbers or intercepting calls.
- Perso page *Perso*
Contains call line keys (allowing supervision of calls) and programmable call keys.
- Info page *Info*
Contains information on the telephone and the status of its functions: name, telephone number, number of messages (including call log events, text messages and voice messages), activation of transfer function, appointment reminder, etc.
-  /  Forward icon: Press the icon (touchscreen) or the key next to this icon to program or change the transfer function.
- Press the label (touchscreen) or press the key in front of the label to select the corresponding feature.
- The 8058s Premium DeskPhone provides 4 programmable softkeys. Press the key in front of the softkey to activate it (call a contact, forward to a number, ...).

Choose the page displayed by default on the telephone

- *Settings* > *Phone* > *Homepage*
- Select the default page (Menu, Perso, Info, Last page seen ...).
- **OK**

1.8 User local menu

Only available on: 8078s BT, 8078s, 8068s BT, 8068s, 8058s, 8028s.

 or  (long press): Open the user local menu.

: this icon is only available on the 8078s Premium DeskPhone.

The user local menu depends on the type of the set.

Audio

Use this menu to adjust the audio convenience according to your environment, the type of device connected and your audio preferences:

- *Jack config.*
Configure the type of the device connected to the audio jack (*Headset, Handsfree, Loudspeaker*).
- *Devices*
Select the preferred audio device (connected or integrated).
- *Hearing Aid*
Check this option if you are using a hearing aid.

Display

Use this menu to adjust the display of your set:

- *Auto-Brightness*
When this option is checked, the phone automatically adjusts the brightness of the display depending on the lighting conditions to improve user experience and achieve power savings (ambient light sensor).
- *Brightness*
Adjust the brightness of the display, the LEDs and the logo on back shell (optional).
- *Advanced > Low brightness*
When the phone is not in use, the brightness is dimmed. Adjust dimmed brightness.
- *Advanced > Busy light*
Activate/deactivate the light of the logo on back shell (optional). The logo on back shell can be illuminated. The color changes when you are busy.
- *Advanced > LED brightness auto*
When this option is checked, the phone automatically adjusts the LED brightness and the busy light logo on the back shell (if present) depending on the lighting conditions to improve user experience and achieve power savings (ambient light sensor).
- *Screensaver*
Set the delay before the brightness is dimmed when the phone is not in use.

Bluetooth®

Use this menu to configure the Bluetooth® device (optional):

- *Devices*
Display all paired Bluetooth® devices, remove a Bluetooth® accessory (headset, handset, etc.).
- *Search devices*
Install a Bluetooth® Wireless accessory (headset, handset, etc.).
- *Parameters*
Use your DeskPhone as a Bluetooth® audio accessory.

 The 8078s Premium DeskPhone has a specific icon (quick access) to manage Bluetooth® devices (add device, list of paired devices, remove device).

Skin

Change the theme (skin) of your phone (optional).

About

Use this menu to find information about the software and hardware releases of your deskphone.

Use this menu to obtain the link to the user manual of your deskphone or the link to the Rainbow home page.







- **Software**
Display all information about your deskphone's software.
- **Hardware**
Display all information about your deskphone's hardware (model, PCMS Number, serial number, mac address, Bluetooth® address if available).
- **Documentation**
Display a QR code to directly access documentation for your deskphone. Scan the QR code and open the URL in your favorite web browser.
- **Rainbow**
Display a QR code to directly access the Rainbow homepage. Rainbow is the cloud-based collaboration application that connects you with your business community. Scan the QR code and open the URL in your favorite web browser.

1.9 Status icons/ Call icons





Icons giving information about some specific configurations of the phone or about call status are displayed in the top bar of the screen.

Status icons

Depending on the size of the display, all status icons may not be displayed simultaneously. Which icons are displayed depends on their priority. The following icons are listed according to their priority, from the highest to the lowest.

























	Silent mode.
	Telephone locked.
	Headset connected.
	Handsfree connected
	Appointment programmed.
	Bluetooth® accessory paired.
	Active Bluetooth® connection.

Call icons

	Incoming call icon.
	Call in progress icon.
	Call holding icon.
	Your contact ended the conversation.

1.10 Permanent features keys

They are located just above the loudspeaker.

8078s 8068s 8058s 8028s	8018	8008	Description
			<ul style="list-style-type: none"> Mute and interphony key. During a call, press this key to stop your contact from hearing you. When idle, press this key to switch the phone to interphony mode. When you receive a call, the phone hooks off automatically and you go straight into hands-free mode. When activated, this key is lit blue.
			<ul style="list-style-type: none"> Turn down the volume (ringing or call state). Decrease the brightness (idle state). Decrease the contrast (idle state).
			<ul style="list-style-type: none"> Turn up the volume (ringing or call state). Increase the brightness (idle state). Increase the contrast (idle state).
			<ul style="list-style-type: none"> Pressing this key answers an incoming call in hands-free mode (when activated, the key is lit blue). When a call is in progress, pressing this key switches from hands-free mode to headset or handset mode. If the headset is connected, you automatically answer the call with the headset. A long press activates the loudspeaker when a call is in progress via the handset or headset.
			<ul style="list-style-type: none"> Programmable keys (F1 and F2 keys). Lit when the function associated with the key is activated. A service or a direct call can be associated to these keys.
			<ul style="list-style-type: none"> Redial key: to access the 'Redial' feature. <ul style="list-style-type: none"> Last number redial (short press). Call back one of the last 8 numbers dialed (long press).
			<ul style="list-style-type: none"> Quick access to user local menu (long press). Used to obtain information on functions of the 'menu' page and to program key of the 'perso' page (short press). <p>For the phones 8008 and 8018 DeskPhone, information about the user is displayed by long pressing on the alpha-numeric key.</p>
			<p>Messaging key to access the messaging portal (call log, voice messages and text messages).</p> <p>This key flashes blue when there is a new event such as a new voice message, a new instant message or a new event in the call log. The key remains lit until all events are acknowledged or deleted.</p>

1.11 Keyboard

1.11.1 Magnetic alphabetic keyboard (8078s, 8068s, 8058s, 8028s Premium DeskPhone)





Your set is provided with a magnetic alphabetic keyboard. The keyboard depends on your country and languages. The magnetic keyboard is automatically fixed on the base of the set. It is connected to the corresponding connector behind the phone.



- Country variants:
 - AZERTY
 - QWERTZ
 - QWERTY (international)
 - QWERTY (nordic)

Use the keyboard to enter names while configuring the phone. Directly access the dial by name feature by entering the name of your contact on the keyboard.





Below is a list of the function keys that allow you to access all the symbols.





	Cursor moving keys (left, right, up and down). Allows you to navigate edit boxes. Press the Alt key to access the left and up directions.
	Caps lock: to write text in capital letters.
	Alt key: to access specific and punctuation characters.
	Enter key: to validate edited text.
	Backspace key: to delete one character in an edit box.

1.11.2 Alpha-numeric keyboard (8008/8018 DeskPhone)

Your phone is equipped with alphanumeric keyboard. You can switch between numeric keyboard to dial number, and alphabetic keyboard to enter text by pressing the corresponding preprogrammed key (usually the first preprogrammed key).

-  Switch the keyboard to the alphabetic mode by selecting the associated preprogrammed key. When activated, the LED corresponding to the key remains lit up.
- Enter alphabetic characters.
The number pad keys have letters that you can display by successive presses. The number is the last character in the series. Some special characters can be displayed by successively pressing the key:

	% \$ / ~ & () [] = *
	@ #
	space - _ 1
	+ . , ; : / ? ! < > 0

-  Use navigation keys to move the cursor into the text.
-  Press and hold the '*' key to switch from lowercase to uppercase mode, and vice versa.
-  use this key to delete the last entered character. The alphabetic mode remains activated.
-  Select the lit preprogrammed key to return to the numeric mode.

1.12 Description of the connectors

Various connections to allow phone extensions. The type of connectors you have depends on your phone.

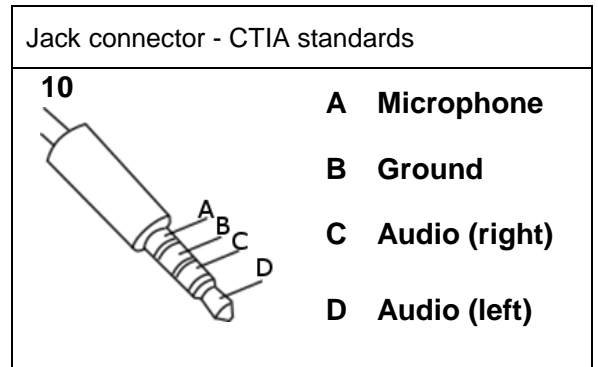
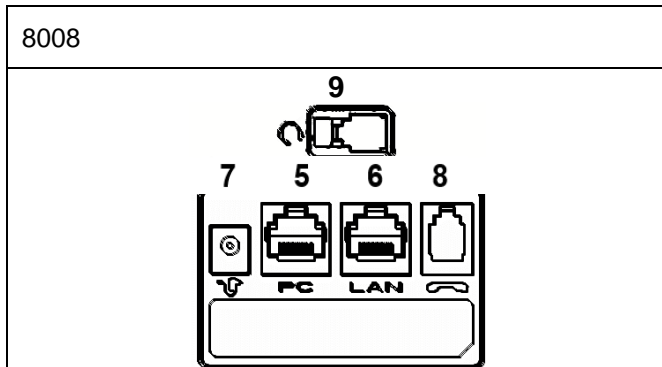
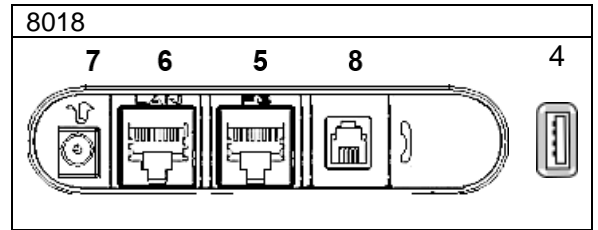
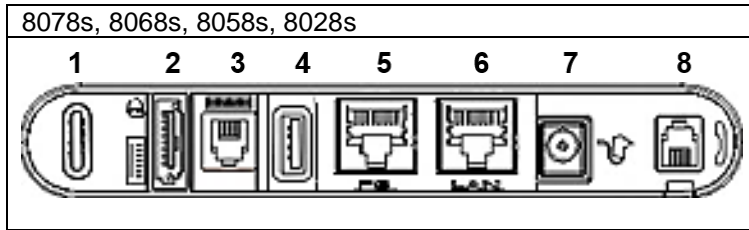

		8078s	8068s	8058s	8028s	8018	8008
1	Universal Serial Bus (USB-c) connector	●	●	●			
2	Add-on module/external ringing connector (SATA type).	●	●	●	●		
3	Magnetic alphanumeric keyboard connector (RJ 9).	●	●	●	●		
4	Universal Serial Bus (USB-a) connector for audio equipment, a low-energy smartphone charger, USB stick, Bluetooth® USB dongle provided with a Bluetooth® headset or an external ringing module. For the 8018 DeskPhone, the USB connector is on the side of the deskphone.	●	●	●	●	●	
5	10/100/1000 Mbps Ethernet connectors to a PC (RJ45).	●	●	●	●	●	
	10/100 Fast Ethernet connector (PC).						●
6	10/100/1000 Mbps Ethernet connectors to the enterprise network (LAN - RJ45).	●	●	●	●	●	
	10/100 Fast Ethernet connector (LAN).						●
7	DC power jack for an external power adaptor.	●	●	●	●	●	●
8	Wired handset connector (RJ9).	●	●	●	●	●	●
9	RJ9 connector for a corded headset.						●
10	3.5 mm, 4 pole jack (TRRS standards: CTIA).	●	●	●	●		

1.13 Add-on module

Depending on your DeskPhone, phone capabilities can be extended with add-ons:

	8078s BT	8078s	8068s BT	8068s	8058s	8028s	8018	8008
Premium Add-on 10 keys modules			●	●	●	●		
Premium Smart display 14 keys module	●	●	●	●	●	●		
Premium add-on 40-key modules	●	●	●	●	●	●		



1.13.1 Install the add-on to the deskphone

- **Premium Add-on 10 keys**

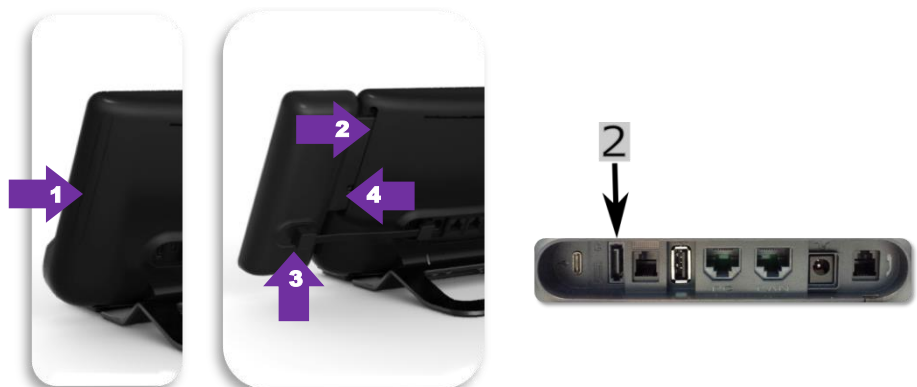

- Remove the protection of the dedicated compartment behind the set.
- Insert the add-on correctly in the compartment.
- Plug the provided cord into the dedicated sockets behind your set and the add-on (2: ).
- Fix the add-on with the provided screw.
- Restart the deskphone (unplug and plug in the power jack if you are using an external power adapter or the Ethernet connector – LAN).



- **Premium Add-on 40 keys / Premium Smart Display 14 keys:**

- Plug the provided cord into the dedicated socket behind your phone and behind the add-on ().
- If desired, fix the foots (set and add-on) with the provided clip.
- Restart the deskphone (unplug and plug in the power jack if you are using an external power adapter or the Ethernet connector – LAN).

Manage and use the add-on keys as a direct call key. See chapter: Programming your telephone.

1.13.2 Install more than one add-on module

It is possible to connect up to three add-on modules (Premium Smart Display 14 keys, Premium Add-on 40 keys). To attach another add-on, affix and connect the new add-on to the one that is already connected:

- The first add-on is connected to the deskphone.
- Plug the provided cord of the new add-on into the dedicated socket behind the connected add-on ().
- Plug the other end of the cord into the dedicated socket behind the new add-on ().
- Restart the deskphone (unplug and plug in the power jack if you are using an external power adapter or the Ethernet connector – LAN).

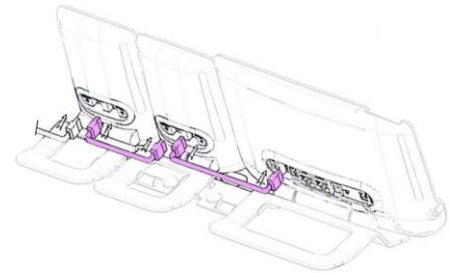

1.13.3 Attach the add-on with the clip

You can also order this clip separately for each of the two add-on modules. You can attach the base (set and add-on module) with the add-on clip provided with Premium Add-on module 40 keys and Premium Smart Add-on module 14 keys.

Premium Smart Add-on

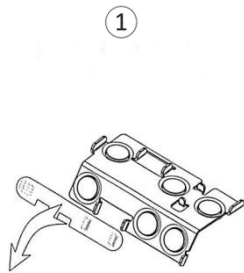

Remove the protection on the add-on clip

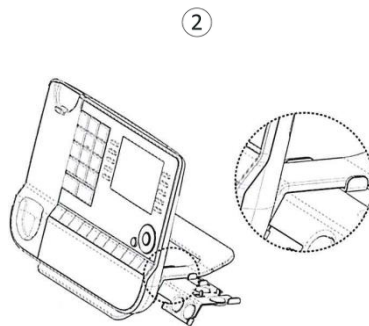

Place the clip in the correct position under the base of the phone, as shown in the image

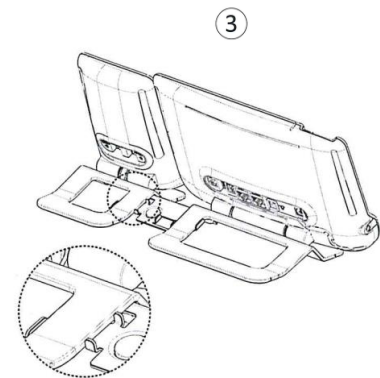

Place the add-on onto the clip, as shown in the image

Premium Add-on 40

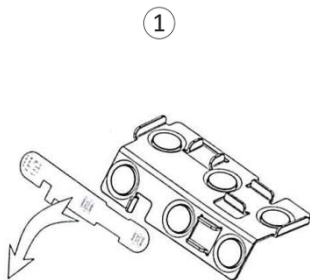

Remove the protection on the add-on clip

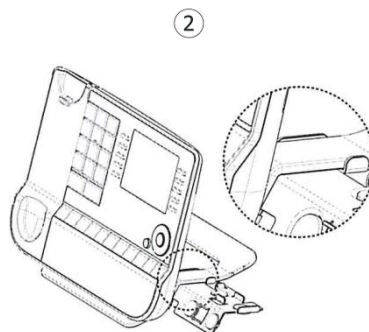

Place the clip in the correct position under the base of the phone, as shown in the image

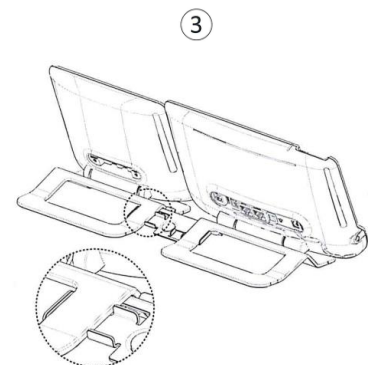

Place the add-on onto the clip, as shown in the image

Use the same procedure to attach an add-on to another add-on.

You can attach one or more add-ons to your phone. To attach another add-on, affix and connect the new add-on to the one that is already connected.

1.13.4 Changing or updating the paper label

- **Premium Add-on 10 keys (with paper labels)**

- Remove the protective cover (1): Insert a thin object (or your fingernail) in the slot (a) to lift the protective cover. Carefully remove the cover at the first notch (b). The cover is held in place by small notches, take care not to break the plastic cover near the notches. Remove the cover from the other notches (c, d) by moving the cover gently from right to left (←→).
- Remove the paper label with a thin object.
- Replace the paper label and protective cover (2): The cover or the paper can only be placed in the right way. It has to cover all the paper area. If not, return it. Position the paper label, right side first, by inserting it under the plastic notches (a). Then, insert the other notches (b) by gently pressing the paper near each notch. Put the protective cover back in the same way.

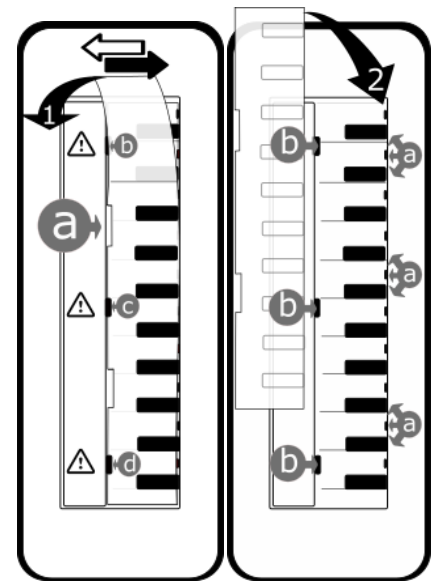

- **Premium Add-on 40 keys (with paper labels)**

- Remove the protective cover (1): Insert a thin object (or your fingernail) in the correct position (a) to lift the protective cover. Carefully remove the protective cover. The cover is held in place by small notches, take care not to break the plastic cover near the notches.
- Remove the paper label in the same way
- Replace the paper label and protective cover (2): The cover or the paper can only be placed in the right way. It has to cover all the paper area. If not, return it. Position the paper label, right side first, by inserting it under the plastic notches (c). Then, insert the other notches (b) by gently pressing the paper near each notch. Put the protective cover back in the same way.
- Follow the same method for each paper area.

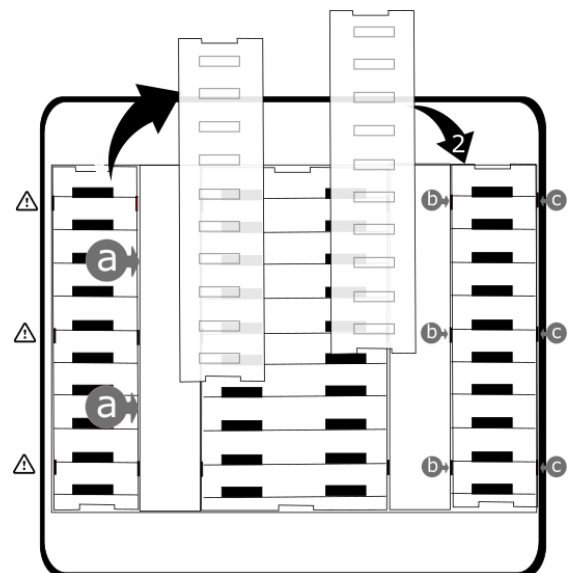

The application 'LabelSet' is available to help you to print the paper labels. Please contact your business partner for more information.

1.14 ALE Wideband Bluetooth® Handset

The Bluetooth® Wireless handset is only available with compatible Bluetooth® deskphones.

	8078s BT	8078s	8068s BT	8068s	8058s	8028s	8018	8008
ALE Wideband Bluetooth® Handset	●		●					

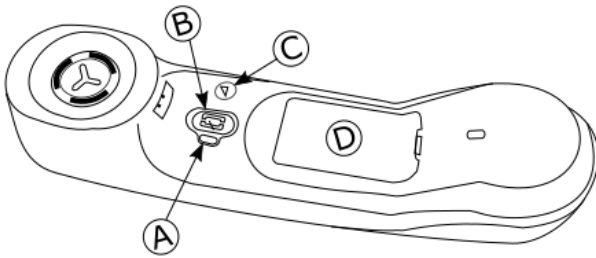

A	<p>LED (Front and back of the device)</p> <ul style="list-style-type: none"> • Blue flashing: Normal operation. • Blue steady: Handset charging. • Red slow flashing: Battery charge low. If voice prompts are enabled, you hear: “Battery low”. • Red fast flashing: Handset outside coverage zone. If voice prompts are enabled, you hear: “Out of Range”. • Red steady: handset not paired.
B	<p>Line key</p> <ul style="list-style-type: none"> • Switch the device on/off: Press and hold to switch the device on/off. If voice prompts are enabled, you hear: “Power On / Power Off”. • Off-hook/On-hook: press this key to take or terminate a call. • Voice prompts (In idle state): Double press to enable the voice prompt.
C	<p>Volume/Mute key</p> <ul style="list-style-type: none"> • Volume (During conversation): Short successive presses to change the handset volume level (3 levels). • Mute (During conversation): Press and hold to ensure your correspondent no longer hears you. • Voice prompts (In idle state): Double press to disable the voice prompt.
D	<ul style="list-style-type: none"> • Location of the battery.

If the Bluetooth® handset is on its base, you do not need to press the Off-hook/On-hook key to take or terminate the call. Just off-hook/on-hook the Bluetooth® handset

The battery recharges when the Bluetooth® handset is on its base. The battery autonomy is more than 10 hours in conversation, and 50 hours in idle state. Charge the battery for about 6 hours before initial use.

If you are not going use the handset for a long time, we recommended that you switch off the device by using the switch at the top of the battery compartment.

1.14.1 Voice prompts

The voice prompts help you to manage functions of the handset. Voice prompts are available in 5 languages. The default language is English. To hear the prompt, the handset has to be near your ear. To select the next language, with the handset turned on, double press the 2 keys of the handset (B,C) at the same time. You hear the new selected language. Repeat until the desired language is reached. To disable the voice prompts, with the handset turned on, double press the Volume/mute key (C). You are notified with a long beep. To enable the voice prompts, with the handset turned on, double press the Line key (B). You are notified with 2 short beeps.

1.14.2 Installing or replacing the Bluetooth® handset battery

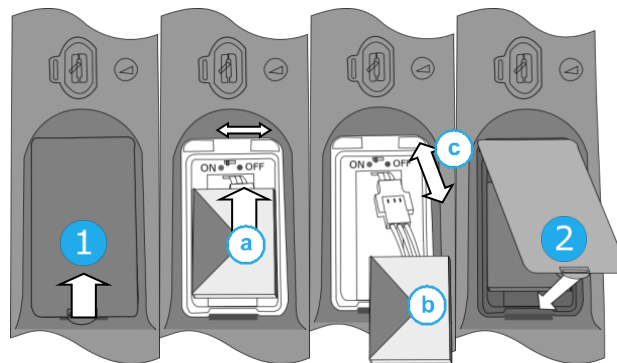

During the first use, to activate the battery, you have to set the switch to ON:

- 1- Lift up the battery cover.
 - a. Set the switch at the top of the compartment to ON using a pencil point.
- 2- Put the cover back on. Take care not to damage the cables when you put the cover on.

To replace the battery, with the handset turned off:



- 1- Lift up the battery cover.
 - a. Set the switch at the top of the compartment to OFF using a pencil point.
 - b. Lift up the battery using the tab to help you.
 - c. Disconnect the old battery and replace it with the new one by joining the 2 connectors. Arrange the battery, the cable and the connectors in the compartment.
- 2- Put the cover back on. Take care not to damage the cables when you put the cover on.

A spare battery can be ordered from your business partner.

1.14.3 Pairing and connecting the Bluetooth® wireless handset

This feature is only available with compatible Bluetooth® deskphone. Otherwise the corresponding menu is not displayed or is inactive.

Before the Bluetooth® handset can be used, it must be correctly paired to the terminal. Pairing will create a wireless link between the Bluetooth® wireless handset and the deskphone.

- 1- Set your deskphone to 'discover' the Bluetooth® wireless handset
 - Use one of the following:
 - 
 -  (long press) › *Bluetooth®*
 - *Search devices*

- 2- Put the handset in detectable mode
 - With the handset turned on, press and hold the 2 Bluetooth® handset keys (B, C) at the same time. If voice prompts are enabled, you hear: "Pairing mode, waiting for connection" ».
- 3- Connect the handset with the deskphone
 - Searching for Bluetooth® equipment. Wait for the detected equipment type and address to be displayed.
 - Select the Bluetooth® wireless handset displayed in your deskphone: "ALE BT WB Handset".
 - Add the device by selecting the relevant menu on your deskphone (Depending on the deskphone).
 - If voice prompts are enabled, you hear: "Device connected". The 3-note tone indicates that the handset has been installed correctly. The LED flashes blue or red depending on the battery charge level.

The handset is correctly connected if it appears in the list of connected devices on your deskphone (see user manual of the deskphone). Press the Line key of the handset to test the connection, your deskphone prompts you to enter a number. Please contact your installer if you encounter any problems. Before contacting your installer make sure you have information such as the serial number, the date code and the technical reference that you can find on the battery.

1.15 ALE Bluetooth® Handset

The Bluetooth® Wireless handset is only available with compatible Bluetooth® deskphones.

	8078s BT	8078s	8068s BT	8068s	8058s	8028s	8018	8008
ALE Bluetooth® Handset	●		●					

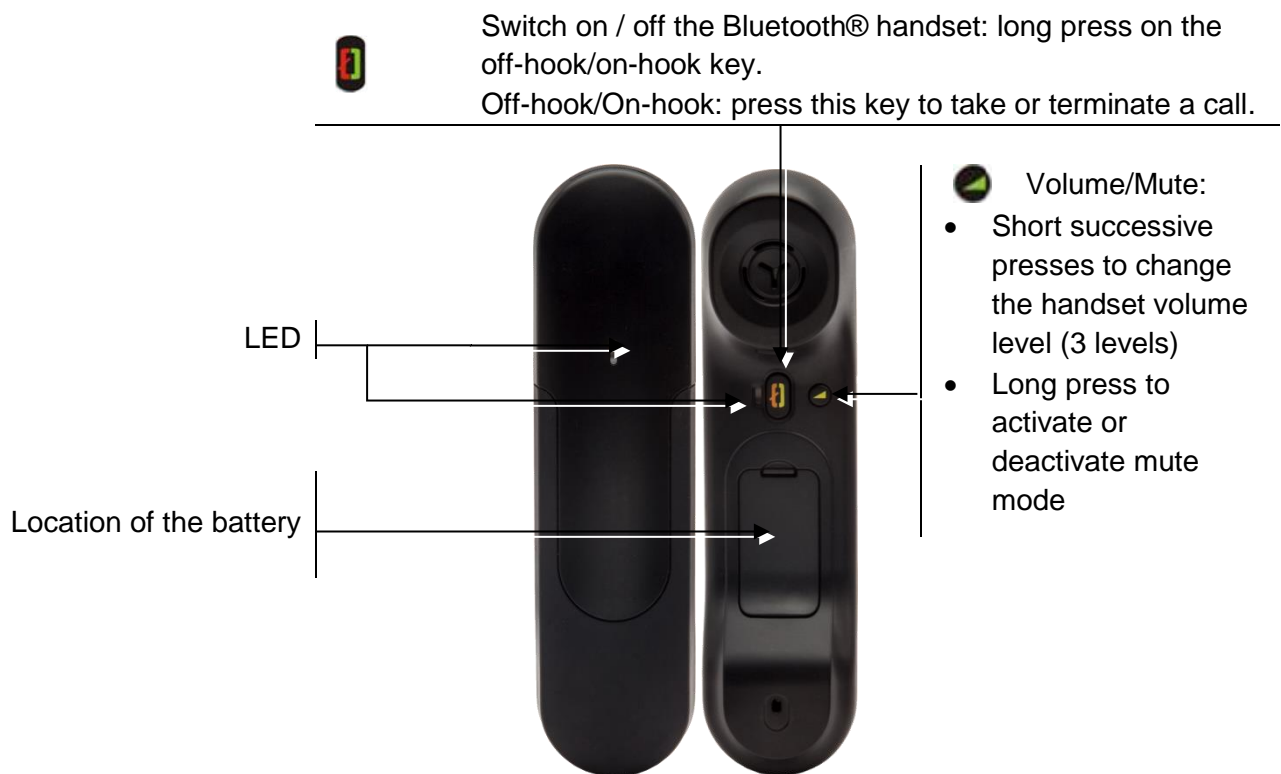

If the Bluetooth® handset is on its base, you do not need to press the Off-hook/On-hook key to take or terminate the call. Just off-hook/on-hook the Bluetooth® handset.

1.15.1 LED

- Off: operating normally.
- Green flashing: in communication.
- Green steady: handset charging.
- Orange flashing: battery charge low or handset outside coverage zone.
- Orange steady: malfunction.

If the Bluetooth® handset is on its base, you do not need to press the Off-hook/On-hook key to take or terminate the call. Just off-hook/on-hook the Bluetooth® handset.

1.15.2 Installing or replacing the Bluetooth® handset battery

At the first use, you have to connect the battery to the handset. The battery is placed in its compartment but it is not connected. To install a new battery, follow instruction:

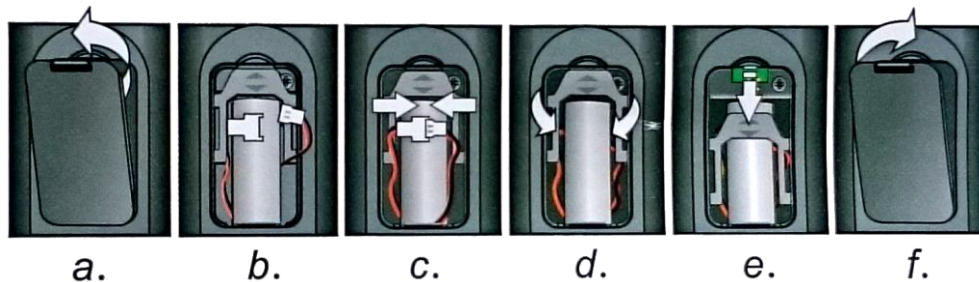

- | | |
|--|--|
| <p>a) Lift up the battery cover.</p> <p>b) Take the 2 connectors.</p> <p>c) Assemble the 2 connectors.</p> | <p>d) Arrange the battery, the cable and the connectors in the battery compartment (place the connected side of the battery in the bottom of the compartment)</p> <p>e) Slide out the battery holding part.</p> <p>f) Replace the cover.</p> |
|--|--|

The battery recharges when the Bluetooth® handset is on its base.



Switch on / off the Bluetooth® handset: long press on the off-hook/on-hook key.

Defective batteries must be returned to a collection point for chemical waste disposal.

1.15.3 Pairing and connecting the Bluetooth® wireless handset

This feature is only available with compatible Bluetooth® deskphone. Otherwise the corresponding menu is not displayed or is inactive.

Before the Bluetooth® handset can be used, it must be correctly paired to the terminal.

- Use one of the following:
 - 
 -  (long press) › *Bluetooth®*
- *Search devices*
-  With the handset turned off, press the 2 Bluetooth® handset keys at the same time (long press).

›› You will hear a 3 note signal and the LED will flash green and orange alternately.

›› Searching for Bluetooth® equipment. Wait for the detected equipment type and address to be displayed.

- Select the relevant equipment: ALE BT Handset.
- *Add*
- Enter the PIN code of the device if necessary.
- *Confirm* ›› The 3-note tone indicates that the handset has been installed correctly. The LED flashes green or orange depending on the battery charge level.

Error messages

- The Bluetooth® handset emits a sequence of 4 beeps: Your set is an older generation than your Bluetooth® handset.
- The set displays an error message indicating that the set and the Bluetooth® handset are incompatible: Your Bluetooth® handset is an older generation than your set.

1.16 Install a comfort wired handset

You can install a wired handset in place of the Bluetooth® Wireless Handset.

- Remove the rubber.
- Plug-in the wired handset to the appropriate connector (refer to phone description).
- Make sure you position the cable correctly in the compartment intended for that purpose:-:
- Switch off the Bluetooth® Wireless Handset (press and hold the On/Off hook key until you hear distinct tones).

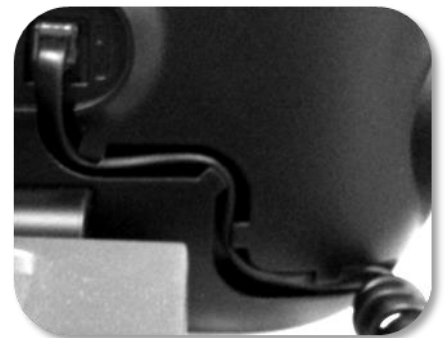

2 Using your telephone

2.1 Identify the terminal you are on

The number of your telephone is displayed on the 'Info' page.

2.2 Messaging portal

The messaging portal allows you to access and manage features such as the call log, instant messaging and voice messages. When there is a new event (new log, new instant message or new voice message) the message key blinks blue.



Accessing the messaging portal

-  Press the message key to access the messaging portal.

Configure access to the messaging portal

The system default setting requires you to enter your personal password to access the messaging portal features. The password information is retained for a few seconds so that if you quit the messaging portal you can access it again after a few seconds without having to re-enter your password. The length of this time-out depends on your system configuration. For more information, contact your installer or administrator.

You can change the setting so that you don't have to enter a password each time you want to access the messaging portal features.





-  Access the messaging portal.
- *Configure*
- *Authentication*
- Enter your personal password.
- Set authentication to on or off.
On: password is always required.
Off: password is never required.
-  Press to confirm.

Accessing the features of the messaging portal

To access the available features (call log, instant messages IM, voice messages, sending an instant message), press the associated softkey.





Acknowledging

When you consult a new event (call log, instant message or voice message), the event is automatically acknowledged. However, you can choose to acknowledge all events without consulting them.

-  Access the messaging portal.
-  Press the associated softkey.
- Enter your password (if required) and apply.
-  Press the softkey associated with the type of event you want to acknowledge. If you press the key associated with the 'all' option, all new events are acknowledged. You can also acknowledge all events if you press the softkey associated with the check icon in the top right corner of the screen.
-  Press to confirm.

Deleting

When consulting an event (call log, instant message or voice message), you can delete the event once you have consulted it. However, you can choose to delete all events in one go.

-  Access the messaging portal.
-  Press the associated softkey.
- Enter your password (if required) and apply.
-  Press the softkey associated with the type of event you want to delete.
-  Press to confirm.

2.3 Consulting the call log

At any time, you can consult all answered and unanswered incoming and outgoing calls. To do this, go to the call log feature on the messaging portal.

-  Access the messaging portal.
- Press the softkey associated with the call log feature.
- Enter your password (if required) and apply.

You can choose between consulting missed calls only ('Missed' tab) and consulting all call logs including unanswered/answered, incoming and/or outgoing calls ('All' tab).

Consult missed calls



- Select the 'Missed' tab.
Unacknowledged calls are in bold characters.
- Select the log to consult.
-  Display the log details.

Information such as the name, phone number, date and time are displayed on the screen.

You can choose to call the contact, send an instant message to the contact, save the contact in the personal phonebook, or clear the log.



Acknowledge all missed calls

Once a new log is consulted, it is automatically acknowledged. However, you can acknowledge all new missed calls without consulting them.

-  Press the associated softkey.
-  Press the associated softkey: *missed call*.
-  Press to confirm.









All missed calls are acknowledged.

Delete all missed calls.

-  Press the associated softkey.
-  Press the associated softkey.
-  Press to confirm.
All missed calls are deleted.

Consulting all calls



- Select the 'All' tab.
All calls are displayed with an icon giving information on the type of call.

		Answered outgoing calls.
		Unanswered outgoing calls.
		Answered incoming calls.
		Unanswered incoming calls.



- Scroll through the list by using the navigation keys (If more than one page).
-  Display the contact information by selecting it in the list. Information such as the name, phone number, date and time are displayed on the screen.

You can choose to call the contact, send an instant message to the contact, save the contact in the personal phonebook, or clear the log.

Acknowledge all missed calls





-  Press the associated softkey.
-  Press the associated softkey: *missed call*.
-  Press to confirm.
All missed calls are acknowledged.

Delete all call logs

-  Press the associated softkey.
-  Press the associated softkey.
-  Press to confirm.
All call logs are deleted.

2.4 Making a call

Use one of the following:

- Dial the destination number. The hands-free mode is activated automatically.
- Unhook the handset › Dial the destination number.
- Press the Off-hook key of the headset › Dial the destination number. If your headset has no Off-hook/On-hook key, use the phone keys and switch on the audio on the headset ()
-  Press the on-hook/off-hook key of the Bluetooth® device (Bluetooth® Wireless handset) › Dial the destination number.
-  Hands-free › Dial the destination number.
- Programmed line key.
- Dial by name (enter the first letters of the contact's name on the alphapad and press OK to start the search).
-  Redialing from the call log.
-  Redial last number.

To make an external call, dial the outside line access code before dialing your contact number.

For the phones 8018/8008 DeskPhone, the redial key is associated with the Off-hook key when the phone is in idle state: .

The duration of your external call may be limited in time by the administrator. In this case, a beep sounds and/or a message will be displayed on the screen 20 seconds before the end of the communication.







If the internal or outside number does not reply

- *Interphony*: Broadcast a message on the loudspeaker of the free terminal.
- *Callback*: Request callback to a busy terminal.
- *Text*: Send a written message.

2.5 Receiving a call

Answer the call depends on audio devices connected to you phone: handset, headset, hands-free, external hands-free or loudspeaker.

Use one of the following:

- Lift the handset to take the call.
-  Press the On-Hook/Off-Hook key on the Bluetooth® handset to take the call (if handset is not on-hooked) - Bluetooth® Wireless handset.
- Press the On-Hook/Off-Hook key on the headset to take the call.
-  or  or  Press the 'take the call', 'loudspeaker' or 'line key' key to take the call in hands-free mode. If the headset is connected, you automatically answer the call with the headset.
- *Take call* or  Take the call with the headset if connected, or in hands-free mode. If the headset is connected, you automatically answer the call with the headset.
-   Select the incoming call icon. If the headset is connected, you automatically answer the call with the headset.
- Press dedicated line key on external handsfree to take the call in hands-free mode on this device.

2.6 Switching between audio modes

During the conversation, you can switch between different audio modes (handset, loudspeaker, hands-free or headset, if connected) by pressing the loudspeaker/hands-free key until the desired audio mode is displayed: . This feature depends on connected devices and the default device selected in the phone configuration. If you have connected the same type of accessory via different connection methods (for example, a headset to the jack connector, a headset to the USB connector and a Bluetooth® headset), the default device is used for audio switching. The key is lit when the loudspeaker or hands-free mode is selected.

You are in conversation with the handset, you can switch between following audio modes by short pressing on the loudspeaker/hands-free key:



You are in conversation with the headset(headset or headset+loudspeaker), you can switch between following audio modes by short pressing on the loudspeaker/hands-free key:



You are in conversation with the headset and the handset is not hang-up, you can switch between following audio modes by short pressing on the loudspeaker/hands-free key:





To switch the audio to the headset, you have to press the Off-hook key of the headset.

You are in conversation, you can switch to the loudspeaker by long pressing on the loudspeaker/hands-free key (group listening feature):











For each audio mode, during the conversation, you can adjust the volume by pressing the volume keys. The number of levels depends on the audio mode (8 for handset and headset 10 for hands-free and loudspeaker). The selected volume, for each audio mode, will be saved for future conversations.

- During a conversation.
-   Adjust volume by pressing the volume keys.

2.7 Activating the loudspeaker during a conversation (handset lifted) -group listening feature

Activate or deactivate the loudspeaker when you are in conversation using the handset or the headset.

-  Activate loudspeaker (long press)  The key lights up (.
-   Adjust volume by pressing the volume keys (number of levels: 10).
-  Deactivate loudspeaker (long press)  The key is no longer lit (.

Press and release the loudspeaker key to switch to hands-free mode (light steady).

2.8 Making calls by name (company directory)

123<>abc: If your set is not provided with a magnetic keyboard, use the alpha-numeric keyboard to enter letters. You have to switch the keyboard to the alphabetic mode by selecting the associated programmed key. When activated, the LED corresponding to the key remains lit up.

You can call your contact using the search by name feature. The search by name feature provides two modes:



- *Internal*: Predictive search of the corporate directory.
- *Unified*: Classic search of the corporate directory.

Please be aware that predictive searching means that you won't have access to the contact card, and therefore can only call the contact on their company phone.

Switching between the two modes:

- Press a letter to launch the dial by name function.
- *Options*
- The current mode is displayed.
- Select the new mode:
 - *Internal*: The internal directory mode is enabled.
 - *Unified*: The unified directory mode is enabled.
 - *OK*: Stay in the current mode.

2.8.1 Calling a contact using the unified directory

- Enter the first letter of your contact's surname.
When entering the name you can extend the search by adding the first letters of the first name after entering the '#' symbol or pressing: *1stname*
-  Start the search.
- A list of matching names is displayed on the screen. Each contact is displayed with their name and company phone number.
- Use one of the following:
 - Scroll and select your contact in the list of matching names.
 -   Modify the search.

Call your contact using the company phone number

- Press the softkey associated with the company phone number.



Call your contact using another phone number (via contact card):

- Press the softkey associated with the contact name:
The contact card opens and displays information about the contact: last name and first name, several phone numbers (Office, mobile, home), email address, instant message address and the company name. The content of the contact card depends on the company directory.
- Scroll through the screen with the up and down navigation keys and position the cursor on the contact phone number you wish to call.
-  Start the call.
From the contact card you can also send an instant message.

 If information about your contact is truncated, you can use the Guide key to display the complete information (8068s, 8058s, 8028s Premium DeskPhone).

You can change the search by name function to predictive search mode by setting the unified directory to 'Off' in the settings menu (available once a search by name is started). Please be aware that predictive searching means that you won't access the contact card and therefore can only call the contact on their company phone and cannot send instant messages.

2.8.2 Calling a contact using the internal directory (predictive search)

- Enter the first letter of your contact's surname. If your phone is equipped with alpha-numeric keyboard, you enter your contact's name in predictive text mode. In this mode, enter each letter of the name by pressing only once on the key with this letter.
- The search runs as soon as you enter a character (predictive search). The matching names are displayed.
- Use one of the following:
 - use the navigation keys to display the previous and next names.
 -  Press the OK key to start the call with the displayed contact (company phone number).
 -  Modify the search.

You can switch to the other search mode by enabling it in the options menu (available once a search by name is started).

This feature depends on the system configuration. If necessary, contact your administrator...

2.9 Make calls via your programmed call keys (Perso page/F1 and F2 keys/Add-on module)

If you have programmed a direct call key, select it to make the call.

2.10 Filtering calls using the voice mailbox



This service lets you filter incoming calls to your voice mailbox. When your caller leaves his message you can choose to communicate with him. This feature depends on the system configuration. If necessary, contact your administrator.

2.10.1 Activating call screening

- Voice mail filtering programmed key. The programmed key has to be configured by the system.
- Enter your personal password.
- Same key to stop listening and deactivate the screening.

2.10.2 When you receive a call

You hear the message left by your caller.
Use one of the following:



-  Hands-free to take the call.
- Unhook the handset.
-  To stop listening only.

2.11 Redialing

2.11.1 Redialing the last number dialed (redial)

-  (short press) **>>** Last number redial.

2.11.2 Call back on the last 10 numbers dialed

-  (long press).
- Select the number to redial from the last 10 dialed numbers.
-  or **OK** Start the call.

For the phones 8018/8008 DeskPhone, the redial key is associated with the Off-hook key when the phone is in idle state: .

You can also access this feature through the menu:

- Reach the 'Menu' page.
- *Redial list*
- Select the number to redial from the last 10 dialed numbers.

2.12 Requesting automatic callback if internal number is busy

This feature lets you to be automatically called back when your internal contact is free.

- The telephone of the internal caller you are trying to contact is busy, and you want the person to call you back as soon as they are free.
- *Call back* **>>** Callback request acknowledged.
- 

Automatic callback is not available if the set of your contact is free or if you are put on hold when the set is busy.

2.13 Cancelling an automatic callback

- When your phone rings.
- *Call back* **>>** *Cancellation of callback request acknowledged.*

Canceling the callback request is only possible when the contact you tried to reach released the line.

2.14 Receiving interphony calls

You can answer a call without lifting the handset. When you receive a call, you are automatically connected in hands-free mode. The identity of the caller is displayed on the screen.

To activate Terminal idle:

-  >> Corresponding LED lights up.

When your caller hangs up, interphony mode remains active.

To deactivate Terminal idle:

-  >> The corresponding LED goes out.

2.15 Sending DTMF signals

During a conversation you sometimes have to send DTMF signals, such as with a voice server, an automated attendant or a remotely consulted answering machine.

- During a conversation.
- *#MFcode*
- Enter DTMF code.
- *xMFcode* To deactivate the feature.

The function is automatically cancelled when you hang up.





Depending on the system configuration, the DTMF can be activated by default. In this case, you can send DTMF code directly by dialing it during the conversation. But if you want to make a second call during the conversation, you have to deactivate DTMF code before dialing the number.

2.16 Mute, so that your contact cannot hear you



You can hear your contact but he/she cannot hear you:

You can hear your contact but he/she cannot hear you:

2.16.1 From the set

- During a conversation.
-  Disable microphone >> The mute key blinks .
-  Resume the conversation >> The mute key no longer blinks .



2.16.2 From the Bluetooth® handset (Bluetooth® wireless handset)

-  Press the handset volume/mute key (long press) >> The mute key blinks.
-  Press the handset volume/mute key (long press) >> Resume the conversation >> The mute key no longer blinks

2.16.3 From the headset



- Use the mute key of the headset, if there is one, to disable headset microphone or to resume the conversation

2.17 Forwarding calls to your voice message service

- Select the forward icon (the icon depends on your phone:  / ).
- *Immediate VM* >> Forward is acknowledged.
- 



2.18 Consulting your voice mailbox

You are notified of a new event when the message key is flashing. New events are also displayed in the 'Info' page.



-  Access the messaging portal.
- Select the voice message feature (depending on your phone, use touchscreen or the associated softkey).
- Enter your password (if required) and apply.
- Select the new voice messages tab. Use left and right navigation key or press directly on the tab if your phone is equipped with a touch screen.
- Select the message you want to listen to (depending on your phone, use the touchscreen or navigation keys to position the cursor on the message).
-  Select the message to listen to.
Display name of sender, with date, time and ranking of message.
- *Play* >> Listen to message.
- *Clear* >> Erase message.
- *Call* >> Call back sender of message.
- *Sendcopy* >> Copy message.
- *Send IM* >> Send an instant message.

Acknowledge all new voice messages

Once you start listening to a voice message, the message is automatically acknowledged. However, you can acknowledge voice messages without listening to them.

-  Press the associated softkey.
-  Press the associated softkey: *Voice msg*
- 

Delete all messages

-  Press the associated softkey.
-  Press the associated softkey: *Voice msg*
- 





2.19 Sending an instant message to a contact

You can only send an instant message to a colleague connected to the same telephone system (generally, a colleague in your enterprise).

You can send an instant message to a contact by entering either their phone number or their name.



123<>abc: If your set is not provided with a magnetic keyboard, use the alpha-numeric keyboard to enter letters. Use the alpha-numeric keyboard key to switch between the numeric and alphabetic keyboard. When in alphabetic mode, the LED corresponding to the key remains lit up.

2.19.1 Sending an instant message using the search by name feature

-  Access the messaging portal.
- *Send IM*
- Enter the first letters of the name.
When entering the name you can extend the search by adding the first letters of the first name after entering the '#' symbol or pressing: *1stname*.
-  Start the search.
- A list of matching names is displayed on the screen. Each contact is displayed with their name and company phone number.
- Select the contact name (depending on your phone, use touchscreen or the associated softkey). The contact card opens and displays information about the contact: last name and first name, several phone numbers (Office, mobile, home), email address, instant message address and the company name. The content of the contact card depends on the company directory.
- Scroll through the screen with the up and down navigation keys and select instant message address if exists in the contact card.
-  Access instant message writing mode.
- Write the instant message to send.
-  Send the instant message.



2.19.2 Sending an instant message using the phone number



You can only send an instant message to a colleague connected to the same telephone system (generally, a colleague in your enterprise).

-  Access the messaging portal.
- *Send IM*
- Enter your password if required.
- Enter your contact's phone number.
-  Access instant message writing mode.
- Write the instant message to send.
-  Send the instant message.

2.19.3 Status of the instant messages





Once the instant message has been sent, the message is stored in the 'Sent' tab of the instant message feature in the messaging portal. The status of the message is as follows:

-  Press the associated softkey.
-  Press the associated softkey: *IM*

	Instant message has been sent but not yet delivered.
	Instant message has been delivered.
	Instant message has been read.

2.20 Consulting instant messages

You are notified of a new event when the message key is flashing.



-  Access the messaging portal.
- Select the instant message feature (depending on your phone, use touchscreen or the associated softkey).
- Enter your password if required.
- Select one of the following tabs: new messages, received messages, sent messages or all messages. Use left and right navigation key or press directly on the tab if your phone is equipped with a touch screen.
- select the message you want to read (depending on your phone, use the touchscreen or navigation keys to position the cursor on the message).
-  Select the instant message.
- Once the instant message is read, you can:
 -  Answer the instant message by pressing the associated softkey.
 -  Delete the instant message by pressing the associated key.
 -  Press OK to call the sender of the instant message.

When a message is read, the status of the message changes from unread to read on both sides (on the recipient side and the sender side).

You can use the filter key to consult messages sent by or to a particular contact. For example, when you are on a message sent by a contact, pressing the filter key shows only messages sent to or by that contact.

Acknowledge new instant messages



Once a new instant message is read, it is automatically acknowledged. However, you can acknowledge all new instant messages without reading them.

-  Press the associated softkey.
-  Press the associated softkey: *New IM*
- 

All new instant messages are acknowledged

Delete instant messages

When consulting the instant messages, you can choose to delete the messages stored in the following tabs: new, sent, received or all messages.





-  Press the associated softkey.
-  Press the associated with the list you want to delete.
- 

2.21 Answering with an instant message



You can send instant messages to your contacts when you have received an instant message or a voicemail or you can send instant messages when consulting the call log. You can only send an instant message to a colleague connected to the same telephone system (generally, a colleague in your enterprise).

123<>abc: If your set is not provided with a magnetic keyboard, use the alpha-numeric keyboard to enter letters. Use the alpha-numeric keyboard key to switch between the numeric and alphabetic keyboard. When in alphabetic mode, the LED corresponding to the key remains lit up.



2.21.1 Answering an Instant message

-  Access the messaging portal.
- select the instant message feature (depending on your phone, use touchscreen or the associated softkey).
- Enter your password if required.
- Select the tab: *New messages*.
- Using the up and down navigation keys, select instant message you want to answer.
-  Select the instant message.
-  Select this icon to answer the instant message (depending on your phone, use touchscreen or the associated softkey).
- Write the instant message to send.
-  Send the instant message.

2.21.2 Answering a voice message

-  Access the messaging portal.
- Select the voice message feature (depending on your phone, use touchscreen or the associated softkey).
- Enter your password if required.
- Select one of the following tabs: new voice messages or all voice messages. Use left and right navigation key or press directly on the tab if your phone is equipped with a touch screen.
- Select the message you want to answer (depending on your phone, use the touchscreen or navigation keys to position the cursor on the message).
- When details of the voice message are displayed on the screen, press the softkey associated with the instant message.
- Write the instant message to send.
-  Send the instant message.

2.21.3 Answering from the call log

-  Access the messaging portal.
- Select the call log feature (depending on your phone, use touchscreen or the associated softkey).
- Enter your password if required.
- Select one of the following tabs: missed calls or all calls. Use left and right navigation key or press directly on the tab if your phone is equipped with a touch screen.
- Select the call log you want to consult (depending on your phone, use the touchscreen or navigation keys to position the cursor on the message).
-  Select the call log.
- When details of the call log are displayed on the screen, press the softkey associated with the instant message feature.
- Write the instant message to send.
-  Send the instant message.

2.22 Lock / unlock your telephone







 This icon indicates that the phone is locked.

- Reach the 'Menu' page.
- *Lock*
- Enter your password >> Your telephone is locked/unlocked.

3 During a conversation

3.1 Making a second call during a conversation

Use one of the following:



- Dial directly the number for your call.
- Name of second contact.
- *New call* › Number of second contact.
- *New call* › *Redial list* › Select the No. in the last ten issued.
- *New call* › *Indiv.rep.* › Select the programmed key.
- /  (long press) or   › Menu page › *Redial list* › Select the No. in the last ten issued.
-   › Perso page › Programmed line key.
- The first call is on hold.

3.1.1 Recover the call on hold

- You are in conversation with the second contact and the first one is on hold.
- Use one of the following:
 - *Enquiry off*
 - Hang up, your phone is ringing, then answer the call.
- ›› You are in conversation with your first caller again.

If you make an error, hang up: your telephone will ring and you will recover your first call.

3.2 Answering a second call during a conversation

- During a conversation, another person is trying to call you. The name or number of the caller is displayed for a few seconds.
-   Select the incoming call icon.
- The first call is on hold.

Other method:

- If there are two or more simultaneous incoming calls, select the incoming call icon and press the following softkey: *Answer*.
- *Queue* or *Waitqueue* › *Answer*

To return to your first contact and end the conversation in progress:

- Hang up, your phone is ringing, then answer the call.
- ›› You are in conversation with your first caller again.

If you make an error, hang up: your telephone will ring and you will recover your first call.

3.3 Switching between calls (Broker call)

During a conversation, a second call is on hold.

-  Select the call on hold icon from the conversation screen.
» Your first call is placed on hold.

Other method:

- *Answer*
 - Press the Back/Exit key to display the Perso page. Select the call on hold.
- » Your first call is placed on hold.

3.4 Transferring a call

During a conversation, to transfer the call to another number:

You are in communication with a first caller

- Calling a second person during a conversation » The first call is on hold.
- You can transfer the call immediately or wait for your contact to answer before transferring the call.
- *Transfer*
- The two callers are connected.

You are in communication with a first caller. A second caller is on hold.

- You want to connect the first caller with the second.
- *Transfer*
- The two callers are connected.

Transfer between two outside calls is not generally possible (depends on country concerned and system configuration).

3.5 Transfer a call to a voice mail

During the call, you want to transfer your caller to the voice mailbox of another caller

- *TransferVMU*
- Number of second contact.

3.6 Three-way conference with internal and/or external contacts (conference)

- During a conversation, a second call is on hold.
- *xConference (xConf)* » You are in conference mode.

3.6.1 Cancel the conference and recover the last active call before the conference (the other is on hold) (If conference is active)

- *xConference (xConf)*

3.6.2 End the conference with all participants (If conference is active)

Use one of the following:



-  Hang up.
- On hook the handset.

3.6.3 After the conference, to leave your two contacts talking together:

- *xConference (xConf)*
- *Transfer*



3.7 Placing a call on hold (hold)

During a conversation, you wish to place the call on hold and recover it later, on the same telephone.

- During a conversation.
- *Hold* >> Your call is placed on hold  .

Recover the call on hold

Use one of the following:

-   Select the call on hold icon from the conversation screen.
- Hang up, your phone is ringing, then answer the call.
- Press the Back/Exit key to display the Perso page. Select the call on hold.

3.8 Placing an outside call on hold (parking)

You can place an outside call on hold and recover the call on another telephone:

- During a conversation.
- *Park call*
- Enter the number of the parking destination phone.

Retrieve the call from the parking destination phone:

- Reach the 'Menu' page.
- *Pickup* > *Unparkcall*

If the parked call is not recovered within a preset time (default value 1 min 30), it is transferred to the operator.

3.9 Intrusion into an internal conversation (barge-in)

Your contact's line is busy. If the number is not 'protected' and if authorised, you can intrude into the call:

- *xIntrusion*
- Same key to exit (*xIntrusion*).

3.9.1 Protection against intrusion

- Press programmed key. The programmed key has to be configured by the system.
- Enter contact's number.

Protection is cancelled when you hang up.

3.10 Save a number into your personal directory

During a call, to save the number onto a call key:

During a conversation.

- *Savetorep*
- Press a call key on the Perso page.
- Enter the name of your contact.
- Apply.

4 'Meet me' conference

The 'Meet me' function is used to set up a conference with a maximum of 6 persons: the 'master' of the conference (who has the rights for initiating the conference) and the participants (maximum of 5) who meet for the conference.

4.1 Initiate a 'Meet me' conference

In order for the participants to join the conference, you must first decide on a meeting time for the conference and send them the access code.

- Lift the handset.
- Enter the 'Meet me' conference activation code. This code is defined by the administrator during system configuration. If necessary you may need to contact your administrator.
- Enter your telephone number (internal).
- Enter your personal password.
- Enter the conference access code.

The conference is set-up. Participants must enter this access code to join the conference call. Send the conference call access code to the participants.

When the system prompts you to enter a code or password, you are allowed 3 attempts before the system rejects your request.

Call number for activating the 'Meet me' conference: this call number is used by the conference master when he wishes to initiate a conference from an external set. This number must have been defined previously by the system administrator.

4.2 Join a 'Meet me' conference

Once set-up by the conference master, the participants can join the 'Meet me' conference (5 participants maximum).

- Lift the handset.
- Enter the joining code for the 'Meet me' conference. This code is defined by the administrator during system configuration. If necessary you may need to contact your administrator.
- Enter the conference access code.
Conference access code: 4 digit code defined by the conference master and communicated to the participants so that they can join the conference.

You are in conference mode.

When the conference master on-hooks, all the communications will be cut-off.

Call number for joining the 'Meet me' conference: this call number allows the participants to join a conference from an external set.

An audible beep sounds when a participant joins the conference. 2 audible beeps sound when a participant leaves the conference.

You cannot join a conference if there are already the maximum number of participants.

If the conference has not yet been set up by the conference master you are put on hold until the conference is initiated (5 minutes maximum).

If you cannot directly reach the conference, you have to call first an internal user or an automatic operator. This one dials the call number for joining the 'Meet-me' conference and then transfers your call (10 seconds).

5 Sharing

5.1 Receiving supervised call ringing

To receive the special ringing for calls to another number:

- Supervised call ringing programmed key. The programmed key has to be configured by the system.
- Same key to cancel.

5.2 Answering the general bell

When the operator is absent, outside calls to the operator are indicated by a general bell. To answer:

- Reach the 'Menu' page.
- *Pickup* › *Generalbell*

5.3 Manager/Assistant filtering

System configuration allows 'Manager/Assistant' groups to be formed, so that the manager's calls can be directed to one or more assistants.

5.3.1 From the manager or assistant telephone

- Filter programmed key ›› Incoming calls are filtered by a chosen person (assistant, etc.).
- Same key to cancel.

Filtering is indicated on the manager's telephone by the icon corresponding to the 'screening' programmed key.

5.4 Call pick-up

You hear a telephone ringing in an office where no-one can answer. If authorised, you can answer the call on your own telephone.

5.4.1 If the telephone ringing is in your own pick-up group

- Group call pick-up programmed key. The programmed key has to be configured by the system.

5.4.2 If the telephone ringing is not in your pick-up group

- Reach the 'Menu' page.
- *Pickup* › *Set*
- Enter the number of the ringing telephone.

The system can be configured to prevent call pick-up on certain telephones.



5.5 Answering briefly in place of the operator

Outside calls to the operator will ring on your telephone and you can answer the call:

- 'Operator help' programmed key. The programmed key has to be configured by the system.
- Your telephone will ring at the same time as the switchboard.
- Same key to cancel.

Calls to the switchboard:

Calls to the switchboard will ring on your telephone.

- Lift the handset.
-  / 
- 'Operator help' programmed key.

5.6 Hunting groups

5.6.1 Hunting group call:

Certain numbers can form a hunting group and can be called by dialling the group number.

- Lift the handset.
- No. of group to be called.

5.6.2 Temporary exit from your hunting group:/Return into your group:

- Leave group programmed key. The programmed key has to be configured by the system.
- Enter your group number.

Belonging to a group does not affect the management of direct calls. A specific telephone within a group can always be called by using its own number.

5.7 Calling an internal contact on his/her pager

The number called does not answer and you know that the person called has a pager:

- Paging programmed key. The programmed key has to be configured by the system.
- Paging in progress is displayed.

Your contact can answer from any telephone in the system.

5.8 Answering a call on your pager

A call on your pager can be answered from any telephone within the system.

Your pager beeps.

- Answer paging programmed key. The programmed key has to be configured by the system.
- Enter your group number.



5.9 Calling a contact on his/her loudspeaker

Your internal contact does not answer. If authorised, you can remotely activate her/his phone:

- Your contact does not reply.
- *Interphony*

You are connected to the loudspeaker on your contact's phone (if he/she has the hands-free function).





5.10 Send a voice message copy

-  Access the messaging portal.
- Press the softkey associated with the voice message feature: *Voice msg.*
- Enter your password (if required) and apply.
- Select the tab to consult.
- Using the up and down navigation keys, select the voice message you want to send.
-  Select the message to send.
- *Sendcopy*
- Enter the destination number.
- 
- *Sendmessage*

When sending a copy of the message, you can also record a comment to join to the copy.

- *Record*
- Start recording the comment.
- *Stop*
- 

5.11 Sending a recorded message to a number or a distribution list

-  Access the messaging portal.
- Press the softkey associated with the voice message feature: *Voice msg.*
- Enter your password (if required) and apply.
-  Press the associated softkey.
- Use one of the following:
 - Enter the number of the recipient or select a destination list.
 - Enter the name of the recipient using the alphapad.
- 
- *Record*
- Start recording the comment.
- *Stop*
-  Send the message.

5.12 Broadcasting a message on the loudspeakers of a station group

A message not requiring an answer can be broadcasted on the loudspeakers within your broadcast group:



- Off hook.
- Number of broadcast group >> Speak, you have 20 seconds.
-  or Hang up.

The message will only be broadcast on terminals not in use and which have a loudspeaker.

6 Keep in touch



6.1 Selecting calls to be forwarded

When a forward is applied, you can select the types of call to be forwarded: outside, internal, all.

- Select the forward icon (the icon depends on your phone:  / ).
- *Ext/Int* >> Select the type of Out/Int call >> type of call forwarded is displayed.
 - *Allcalls* >> forward internal and outside calls.
 - *External* >> Forward outside calls.
 - *Internal* >> Forward internal calls.

6.2 Forwarding calls to another number (immediate forward)

The number can be your home, mobile, voice mailbox or an internal extension (operator, etc.).



- Select the forward icon (the icon depends on your phone:  / ).
- *Immediate*
- Number to be called >> Forward is acknowledged.
- 

You can also select the destination number of the forward through the redial feature or the individual repertory.



You can make calls, but only the destination number can call you.

6.3 Personal assistant: reaching you with one number only

As well as leaving a message in the voice mailbox, the personal assistant directs the caller to an internal number, an outside number, a mobile or the switchboard.

- Reach the 'Menu' page.
- *Settings* > *Assistant* > *Menu*
- You can then choose where to route the calls:
 - *InternalNr* >> Dial number of a colleague or your assistant.
 - *ExternalNr* >> Dial an outside line number.
 - *MobileNr* >> Dial number of your mobile or DECT.
 - *Operator* >> Activate / deactivate transfer to operator.
- 
- 



6.4 Activate/disable the personal assistant

- Reach the 'Menu' page.
- *Settings* > *Assistant*
- *On* or *Off* >> Activate or deactivate the assistant.
- 
- 

6.5 Forwarding your calls from the receiving terminal ('Follow me')

You wish to receive your calls in your present location:

Use the 'Follow me' function.

- Select the forward icon (the icon depends on your phone:  / ).
- *Followme*
- Enter the number of the phone you want to forward calls >> Forward is acknowledged.
- 

If you have a key programmed with this feature, you can access the feature directly.



- Press programmed key.
- Enter the number of the phone you want to forward calls >> Forward is acknowledged.
- 

6.6 Diverting all group calls

You can forward all your group calls to another internal number:

- Group calls forwarding programmed key. The programmed key has to be configured by the system.
- Enter the number of the phone you want to forward calls.
- Forward is acknowledged.
- 

6.7 Cancelling all forwards

- Select the forward icon (the icon depends on your phone:  / ).
- *Cancellwd.*
- 



To cancel all forwards, you can programme another type of forward too.

6.8 Cancelling a specific forward

- Programmed key corresponding to type of forward (group or selective). The programmed key has to be configured by the system.

6.9 Forwarding calls when your line is busy (forward if busy)



Callers can be forwarded to another telephone if you are already on the line.

- Select the forward icon (the icon depends on your phone:  / ).
- *Onbusy*
- Enter the destination number >> Forward is acknowledged.
- 

6.10 Do not disturb

Callers wishing to contact you will see the 'Do Not Disturb' message displayed on their sets when they try to call.



You can make your terminal temporarily unavailable for all calls.

- Select the forward icon (the icon depends on your phone:  / ).
- *DoNotDisturb* >> Forward is acknowledged.

6.11 Leaving a text message for internal callers

You can leave a text message on your terminal which will be displayed on the screen of the terminal calling you. The caller is informed of the message, and can read it by selecting the following softkey: *Read message*.

123<>abc: If your set is not provided with a magnetic keyboard, use the alpha-numeric keyboard to enter letters. You have to switch the keyboard to the alphabetic mode by selecting the associated programmed key. When activated, the LED corresponding to the key remains lit up.

- Select the forward icon (the icon depends on your phone:  / .
- *Textanswer*
- Choose the type of message.

Sending predefined message

- *FixedMsg*.
- Select the message to be sent.
- 

Select the language of the message that will be displayed: *Language*.

Notice that you can select the message to send by its number by selecting the option: *Gotomessage*.

The 27 standard messages are shown below:

1	Call me back	15	Meeting on ___ (*)
2	Call me back tomorrow	16	Meeting on ___ at _:_ (*)
3	Call me back at _:_ (*)	17	Out for a while
4	Call back _____ (*)	18	Absent for the rest of the day
5	Call the attendant	19	Absent, back at _:_ (*)
6	Call the assistant	20	Absent, back on ___ at _:_ (*)
7	I will call back at _:_ (*)	21	On vacation, back on ___ (*)
8	Use paging	22	External meeting
9	Please fetch your fax	23	External meeting, back on ___ (*)
10	Please fetch your mail	24	I am in room nr ___ (*)
11	Please cancel your forwarding	25	In a meeting - do not disturb
12	Visitors are waiting	26	At lunch
13	You are expected at reception	27	Indisposed
14	Meeting at _:_ (*)	(*)	Messages to be completed using numeric keypad

Sending a new message

- *NewMsg*.
- Write your message.
- 

6.12 Message notification

A message is left in your mailbox but you are not at your desk. You can configure your telephone so that you receive notification of the message on another telephone.

- Reach the 'Menu' page.
- *Settings* > *Notification*
- Press consecutively to activate/deactivate.
- *ON/OFF*
- *Choice* >> Press consecutively to activate/deactivate.
- **OK**

This feature depends on the system configuration. If necessary, contact your administrator...



6.12.1 Change the time slot

The time slot during which notification is activated can be changed.

- *Schedule*
- Change times.
- **OK**

6.13 Forwarding calls to your pager

Callers will thus be able to contact you while you are moving around the company.

- Select the forward icon (the icon depends on your phone:  / ).
- *Topaging* >> Forward is acknowledged.

7 Programming your telephone

7.1 Initializing your voice mailbox

- Light flashes.
- 
- Enter your personal code then record your name according to voice guide instructions.

Your personal code is used to access your voice mailbox and to lock your telephone.

Your password has 6 digits. A weak personal code with 6 identical digits (000000, 111111, etc.) or a simple sequence of 6 digits (012345, 123456, etc.) will be rejected by the system. After a system upgrade, the password may still have only 4 digits. For security reasons, we recommend you use a password with 6 digits. Contact your installer for more information. The list of weak passwords provided does not contain all the possibilities.

7.2 Customizing your voice greeting

You can replace the greeting message by a personal message.

- Reach the 'Menu' page.
- [Settings](#) › [Mailbox](#)
- You can listen to the greeting, customize the greeting and set the default greeting ([Listen, Recordname](#)).
- You can replace the greeting message by a personal message ([Persmessage](#)).
- You can choose between two modes: the automated attendant or recorded greeting ([Mode](#) › [Record mode/Single mode](#))
- You can pause, resume or stop the recording at any time.

7.3 Modifying your personal code

- Reach the 'Menu' page.
- [Settings](#) › [Options](#) › [Password](#)
- Old code (6 digits).
- New code (6 digits).
- 



As long as your voice mailbox has not been initialized, personal code is 515151.

Your password has 6 digits. A weak personal code with 6 identical digits (000000, 111111, etc.) or a simple sequence of 6 digits (012345, 123456, etc.) will be rejected by the system. After a system upgrade, the password may still have only 4 digits. For security reasons, we recommend you use a password with 6 digits. Contact your installer for more information. The list of weak passwords provided does not contain all the possibilities.

7.4 Adjusting the audio functions





- Reach the 'Menu' page.
- *Settings* › *Phone* › *Ringling*
- Enter your password (if required) and apply.

7.4.1 Choose the tune

- *Int. Melody/Ext. Melody*
The tune must be chosen for external and internal calls.
- Select the melody of your choice (17 tunes).
- 
-  End. /  To adjust other audio features.



Of the ringers, one ringer is louder than the others and can be used in noisy environments.

7.4.2 Adjusting the ringer volume



- *Volume*
-   Select the volume you want: (10 levels).
- 
-  End /  To adjust other audio features.

Of the ringers, one ringer is louder than the others and can be used in noisy environments.



7.4.3 Activate/deactivate silent mode

- *Silent*
- *ON/OFF* ›› activate/deactivate.
- 
-  End /  To adjust other audio features.



7.4.4 Activate/deactivate meeting mode (progressive ringing)

- *Progressive*
- *ON/OFF* ›› activate/deactivate.
- 
-  End /  To adjust other audio features.

7.4.5 Activate/deactivate discreet ring mode

- *Beeps*
- *3 Beeps + Ringing*
- *ON/OFF* ›› activate/deactivate.
- 
-  End /  To adjust other audio features.

7.4.6 Adjust ringer volume while a call arrives

- Your telephone rings.
-   Adjusting the ringer volume.

7.5 Adjusting the brightness of the deskphone (8078s, 8068s, 8058s, 8028s Premium DeskPhone)



Adjust the brightness of the display, the LEDs, the keys (add-on) and the logo light on the back shell (optional).

7.5.1 Auto-adjusting of the brightness

The phone can automatically adjust the display brightness, LED and busy light logo on the back shell (if present) depending on the lighting conditions to improve user experience and achieve power savings (ambient light sensor).

: this icon is only available on the 8078s Premium DeskPhone.







Auto-adjusting of the display brightness

-  or  (long press) › *Display* › *Auto-Brightness*
- Activate or deactivate the feature.







Auto-adjusting of the LED brightness and the busy light logo on back shell (if present)

-  or  (long press) › *Display* › *Advanced* › *LED brightness auto*
- Activate or deactivate the feature.







7.5.2 Adjust the brightness when the phone is in use

-  or  (long press) › *Display* › *Brightness*
-   Increase or decrease the brightness.
- 
- 

7.5.3 Adjust the dimmed brightness when the phone is not in use



-  or  (long press) › *Display* › *Advanced* › *Low brightness*
-   Increase or decrease the brightness.
- 
- 

7.5.4 Set the delay before the brightness is dimmed when the phone is not in use (screensaver)

-  or  (long press) › *Display* › *Screensaver*
-   set the time delay (default 4 hours).
- 
- 



: this icon is only available on the 8078s Premium DeskPhone.

7.6 Adjusting the contrast of the display (8028s, 8018, 8008)

- Reach the 'Menu' page.
- *Settings* › *Phone* › *Contrast*
- *Screen* or *Keys* ›› Increase or reduce the brightness of the screen or keys (of the extension unit) by pressing consecutively on the corresponding keys.
- 
- 

7.7 Selecting the welcome page

This function is used to choose the page displayed by default on the telephone.

- Reach the 'Menu' page.
- *Settings* › *Options* › *Homepage*
- Select the default page (Menu, Perso, Info, Last page seen ...).
- 
- 

7.8 Selecting language

- Reach the 'Menu' page.
- *Settings* › *Options* › *Language*
- Select the language of your choice.
- 



7.9 Programming direct call keys (Perso page/F1 and F2 keys/Add-on module)

123<>abc: If your set is not provided with a magnetic keyboard, use the alpha-numeric keyboard to enter letters. Use the alpha-numeric keyboard key to switch between the numeric and alphabetic keyboard. When in alphabetic mode, the LED corresponding to the key remains lit up.





Depending on your deskphone, you can program:

- Softkeys of the Perso page.
 - Keys/softkeys of the add-on module.
 - F1 and F2 keys.
 - Programmable keys with LED and paper.
 - Programmable keys with LED and paper.
- Led behavior may differ depending on the system configuration. For more information, contact your installer or administrator.





If the key is not programmed yet:

- Select the key to program.
- *Name:* Enter the name of the key.
- 
- *Number:* Enter the number to associate with the key.
- 
- 



If the key is already programmed:

-  (or *Settings* > *Keys*)
- Select the key to program.
- *Name*: Enter the name of the key.
- 
- *Number*: Enter the number to associate with the key.
- 
- 

7.10 Modifying direct call keys

-  (or *Settings* > *Keys*)
- Select the key to modify.
- *Name*: Enter the name of the key.
- 
- *Number*: Enter the number to associate with the key.
- 
- 
- 

7.11 Deleting direct call keys

-  (or *Settings* > *Keys*)
- Select the key to delete.
- *Clear*
- 

7.12 Programming an appointment reminder

You can set the time of a temporary reminder (one within 24 hours) or a permanent reminder (every day at the same time).

- Reach the 'Menu' page.
- *Appointment*
- Enter time of appointment.
- *Temporary/ Permanent* >> Select the type of appointment (temporary or permanent).
- 

The 'Appointment programmed' icon is displayed on the welcome page.

At the programmed time, your phone rings:

- 

If your calls are forwarded to another terminal, the forward is not applied to the reminder call.

To cancel your reminder request:

- Reach the 'Menu' page.
- *Appointment*
- *Temporary/ Permanent* >> Select the type of appointment (temporary or permanent).
- *Clear*
- 

The 'Appointment programmed' icon disappears from the welcome page.

7.13 Install a jack accessory (headset, hands-free, loudspeaker) (8078s, 8068s, 8058s, 8028s Premium DeskPhone)

Your phone is equipped with a 3.5 mm, 4 pole jack. If your device is not compatible, you can use a 3 pole to 4 pole jack adapter.

By default, the audio jack of your telephone can be used to connect a headset, hands-free kit or loudspeaker. A wideband headset can also be installed for optimized sound quality.



When you plug the jack accessory in the jack, a popup asks you for the type of accessory:

- *Headset*
- *Handsfree*
- *Loudspeaker*

If another headset is already connected (USB or Bluetooth® if available), a popup asks you to select your preferred headset.

A specific icon is displayed in the status bar: .

If necessary, you can also select the accessory type in the audio settings:



-  or  (long press) > *Audio*
- *Jack config.*
- *Headset / Handsfree / Loudspeaker* >> Select the type of device plugged into the jack.
- 

: this icon is only available on the 8078s Premium DeskPhone.

7.14 Install a USB accessory (Headset, Handsfree, Loudspeaker)

- Connect the accessory to the USB connector.
- When you plug the accessory in the USB port, the USB accessory is automatically detected. If an another accessory is already connected with the same function (USB, jack or Bluetooth® if available), a popup asks you to select your preferred accessory to use for this function.

If necessary, you can also select the accessory type in the audio settings:

-  or  (long press) > *Audio*
- *Devices*
- The list of connected devices is displayed.
- Select the type of device connected to the USB.
 - *Headset*
 - *External hands-free*
 - *External loudspeaker*
- 



If you are using a Bluetooth® headset provided with a Bluetooth® USB dongle, you can connect the headset to the USB connector. Use and connectivity depend on the vendor of the headset.



: this icon is only available on the 8078s Premium DeskPhone.

7.15 Manage connected devices

: this icon is only available on the 8078s Premium DeskPhone.



7.15.1 List of connected devices

-  or  (long press) › *Audio*
- *Devices*
- The list of connected devices is displayed. You can find information about the connector:

-  : USB.
-  : Jack.

7.15.2 Default device

If you have connected the same type of accessory onto different connectors (for example, one headset to the jack connector, one headset to the USB connector and one Bluetooth® headset), the list of used connectors is display for each type of accessory. You can select your preferred accessory to be used as the default accessory.

-  or  (long press) › *Audio*
- *Devices*
- The list of connected devices is displayed.
- Select the device with more than one connector icons.
- Select your preferred accessory

7.16 Activating/Deactivating 'Forced headset' mode

Forced headset mode must be activated as soon as a headset is installed instead of the handset.

- Reach the 'Menu' page.
- *Settings* › *Phone* › *ForcedHead*
- *ON/OFF* › activating/deactivating forced headset.

7.17 Installing and using an ALE Bluetooth® wireless handset

This feature is only available with compatible Bluetooth® deskphone. Two Bluetooth® handsets are provided by ALE International.

Please consult the following chapter depending on the handset in your possession (grey or color buttons):

- ALE Wideband Bluetooth® Handset.
- ALE Bluetooth® Handset.

7.18 Installing a Bluetooth® Wireless Technology headset (pairing)



This feature is only available with compatible Bluetooth® deskphone. Otherwise the corresponding menu is not displayed or is inactive.

A multi-point Bluetooth® headset can be provided by ALE International.

This headset can be paired to your mobile phone and other communication devices at the same time. For example, you can use the headset paired to your mobile and when you enter your office the headset automatically matches to your office set too.

You can then answer a call using your Bluetooth® headset or the Bluetooth® Handset on the office set.

Before a Bluetooth® headset can be used, it must be correctly paired to the terminal. Before performing the pairing operation, the headset must be in detectable mode.

- Use one of the following:
 - 
 -  (long press) › *Bluetooth®*
- *Search devices*

›› Searching for Bluetooth® equipment. Wait for the detected equipment type and address to be displayed

- Select the relevant equipment.
- *Add*
- Enter the PIN code of the headset*.
- *Confirm* ›› Acknowledgement message and display of the headset icon on the terminal screen.

*Refer to the user documentation supplied with the headset.

: this icon is only available on the 8078s Premium DeskPhone.



7.19 Using a Bluetooth® Wireless Technology headset

This feature is only available with compatible Bluetooth® deskphone. Otherwise the corresponding menu is not displayed or is inactive.

Refer to the user documentation supplied with the headset.

7.20 Display all paired Bluetooth® devices



This feature is only available with compatible Bluetooth® deskphone. Otherwise the corresponding menu is not displayed or is inactive.

- Use one of the following:
 - 
 -  (long press) › *Bluetooth®*
 - *Devices*
- ›› Display of the different equipment paired.

: this icon is only available on the 8078s Premium DeskPhone.

7.21 Removing a Bluetooth® accessory (headset, handset, etc.)

This feature is only available with compatible Bluetooth® deskphone. Otherwise the corresponding menu is not displayed or is inactive.

- Use one of the following:
 - 
 -  (long press) › *Bluetooth®*
 - *Devices*
- ›› Display of the different equipment paired.
- Select the equipment to be removed.
 - *Remove*
 - 



›› Message acknowledging the equipment has been removed.

: this icon is only available on the 8078s Premium DeskPhone.

7.22 Pair your phone as a Bluetooth® device

This feature is only available with compatible Bluetooth® deskphone. Otherwise the corresponding menu is not displayed or is inactive.

Your phone can be used as a Bluetooth® device (loudspeaker for example). Before performing the pairing operation, your phone must be in detectable mode.

- Use one of the following:
 - 
 -  (long press) › *Bluetooth®*
- *Parameters* ›› Display of the different equipment paired. A specific icon is displayed on the screen 
- On the device you want to pair to your phone, scan Bluetooth® devices and select the device (the name of your deskphone is displayed on the screen).
- Accept the prompt for pairing your deskphone with the device.

: this icon is only available on the 8078s Premium DeskPhone.

7.23 Configure your phone for teleworking

Your IP phone is compatible with teleworking (VPN) via a secure connection (encrypted). In this mode, all features available at your office will be ready for use remotely.

If the telephone system of your enterprise is configured to accept remote workers (system and infrastructure), you have to configure your deskphone to be ready for teleworking.

The configuration of the phone depends on the infrastructure of your telephony network.

For information, please consult the following guide:

- “IPsec VPN Deployment Guide for Remote Workers for DeskPhones and Premium DeskPhones s Serie “ 8AL90345ENAA (<https://businessportal2.alcatel-lucent.com/8AL90345ENAA>)

In this section, we describe the complete configuration of your phone for teleworking.

Your installer has to give you all information to configure your deskphone.

You have to:

- Enable VPN.
- Enter the remote VPN server information.
- Enter the TFTP server information (optional).
- Enter authentication.
- Setup the VPN start preferences.

7.23.1 First connection as teleworking

When you connect your deskphone for the first time remotely, you are prompted to set a PIN code.

The PIN code is requested when you enter in the VPN configuration (submenu) or when you boot your deskphone (depending on the VPN configuration).



The PIN code is retained during the session so that you can access the VPN configuration without having to re-enter your PIN code until you exit the VPN configuration.

Before configuring your phone for teleworking, check if you have all the information from your administrator.

123<>abc: If your set is not provided with a magnetic keyboard, use the alpha-numeric keyboard to enter letters. Use the alpha-numeric keyboard key to switch between the numeric and alphabetic keyboard. When in alphabetic mode, the LED corresponding to the key remains lit up.

To configure your deskphone:

- Connect your deskphone to the network (and plug in the power jack if you are using an external power adapter).
- When the deskphone displays the 'Step 2' during the boot, repeatedly press the '*' and '#' keys in succession until a menu is displayed.
- **VPN** (Scroll down the menu).
 - **VPN Config**
 - Enter the new PIN Code.
 - Validate.
 - **Enable VPN**: you have to activate this option to use your deskphone for teleworking.
 - **Server**: enter the address of the VPN server.
 - **PSK**: enter the pre-shared key to establish a secure connection with the VPN server. The PSK can be unique for all remote workers on a same installation or can be specific to each remote worker. In the first case, the VPN authentication has to be enabled.

- *VPN Tftp* › *Use TFTP servers, tftp1, tftp2, port*: if the TFTP servers are required, activate this option and enter the addresses and port of the TFTP servers.
- *VPN Auth* › *Use Authentication, User, Pass*: activate this option if a logon to the VPN server (username and password) is required. The VPN authentication can be disabled in case a specific PSK is used for each remote worker.
- *VPN Pincod* › *Request Pin on Boot*: if this option is activated, the PIN code is required when you boot your deskphone. We recommend you activate this option.
-  Select this icon to return to the main menu.
- Select this icon to save parameters.
- The VPN configuration is saved and the main menu is displayed.
-  select this icon to exit the configuration menu. The deskphone restarts.
- Enter the PIN code if you have selected the option (*Request Pin on Boot*).
- Validate.
- Your deskphone is ready for teleworking.

If you leave the PIN code request menu when the phone is starting, the phone will start without VPN activated.

If an error occurs when your phone is running in remote mode, a popup is displayed with an error message. Please note this message to send to your administrator.

7.23.2 Change the configuration

You have to change a parameter of the VPN configuration.

- Restart the deskphone (unplug and plug in the power jack if you are using an external power adapter or the Ethernet connector – LAN).
- When the deskphone displays the 'Step 2' during the boot, repeatedly press the '*' and '#' keys in succession until a menu is displayed.
- *VPN* (Scroll down the menu).
- Select a submenu to change the configuration (*VPN Config, VPN Tftp, VPN Auth, VPN Pincod*).
- Enter your PIN code (if an administrator password is defined by the system, you can use it to access to the VPN configuration by selecting: *Use Password*).
- Validate.
- Change parameters.
- Select this icon to save parameters.
- The VPN configuration is saved and the main menu is displayed.
-  select this icon to exit the configuration menu. The deskphone restarts.
- Enter the PIN code if you have selected the option (*Request Pin on Boot*).
- Validate.
- Your deskphone is ready for teleworking.

If an error occurs when your phone is running in remote mode, a popup is displayed with an error message. Please note this message to send to your administrator.

7.23.3 PIN code

The PIN code is composed of 4 digits. You can access the VPN configuration by entering the PIN code or the administrator password if defined by the system. Depending on the VPN configuration, the PIN code is requested when you boot your deskphone. We recommend you enable this option for security reasons and if you need your phone in remote and in business place (see Reconnect your deskphone in your business place).



If the PIN code is incorrect 5 times in succession, the PIN code and VPN parameters will be erased. If no administrator password is defined by the system, the PIN code is required to access VPN configuration.

7.23.4 Reset your PIN code

- Restart the deskphone (unplug and plug in the power jack if you are using an external power adapter or the Ethernet connector – LAN).
- When the deskphone displays the 'Step 2' during the boot, repeatedly press the '*' and '#' keys in succession until a menu is displayed.
- *VPN* (Scroll down the menu).
- *VPN Pincod*
- Enter your PIN code.
- Validate.
- *Set new Pincode*: enter the new PIN Code.
- Select this icon to save parameters.
- The VPN configuration is saved and the main menu is displayed.
-  select this icon to exit the configuration menu. The deskphone restarts.
- Enter the PIN code if you have selected the option (*Request Pin on Boot*).

7.23.5 Reconnect your deskphone in your business place

Your phone is already configured for teleworking.

- Connect your deskphone to the network (and plug in the power jack if you are using an external power adapter).
- If the option to enter PIN code when you boot your deskphone is enabled in the VPN configuration (*Request Pin on Boot*):
 - The PIN code is requested.
 -  Select this icon to go back.
 - The phone restarts in normal mode. The VPN is temporary disabled until the next reboot.
- If the option is not enabled:
 - When the deskphone displays the 'Step 2' during the boot, repeatedly press the '*' and '#' keys in succession until a menu is displayed.
 - *VPN*  *VPN Config*
 - Enter your PIN code.
 - Validate.
 - *Enable VPN*: Disable the teleworker.
 - Select this icon to save parameters.
 - The VPN configuration is saved and the main menu is displayed.
 -  select this icon to exit the configuration menu.
 - The phone restarts in normal mode.

7.23.6 Reconnect your deskphone in remote place

Your phone is already configured for teleworking but it was connected in your place of business. You need to reconnect it in a remote place.

- Connect your deskphone to the network (and plug in the power jack if you are using an external power adapter).
- If the option to enter PIN code when you boot your deskphone is enabled in the VPN configuration (*Request Pin on Boot*):
 - The PIN code is requested.
 - Enter PIN code.
 - Validate.
 - The phone starts as teleworker.
- If the option is not enabled (*Request Pin on Boot*):
 - When the deskphone displays the 'Step 2' during the boot, repeatedly press the '*' and '#' keys in succession until a menu is displayed.
 - *VPN > VPN Config*
 - Enter your PIN code.
 - Validate.
 - *Enable VPN*: Enable the teleworker.
 - Select this icon to save parameters.
 - The VPN configuration is saved and the main menu is displayed.
 -  select this icon to exit the configuration menu.
 - The phone starts as teleworker.

If an error occurs when your phone is running in remote mode, a popup is displayed with an error message. Please note this message to send to your administrator.

8 Contacting your administrator (Technical support)

If necessary you may need to contact your administrator.

Before contacting your administrator, make sure you have information such as your phone's codes and software version to hand.

8.1.1 Date code (right) / Technical code (left)

The codes are located under the backshell of the phone. This label is an example and does not represent the one placed on your phone.

1	Date code (right)
2	Technical code (left)



8.1.2 Software version

The software version can be viewed on the phone by following this path:

- Use one of the following:
 -  (long press) › *About* › *Software*
 - Reach the 'Menu' page › *Settings* › *Options* › *Version*

8.2 Hardware model

The hardware model can be viewed on the phone:

-  (long press) › *About* › *Software* (if available on your phone).

8.3 Phone auto test

The auto test of the phone is a quick hardware test of the sound, the display and the LEDs. It lets the user do the first tests directly from the desktop.

- The phone is switched on and connected.
- Reach the 'Menu' page.
- *Settings* › *Options* › *Phone test*
- Auto test has started.
-  To stop the auto test.

9 ACD: Agent set/ Supervisor station

	8078s BT	8078s	8068s BT	8068s	8058s	8028s	8018	8008
This feature is supported by the following deskphones	●	●	●	●	●			

9.1 Agent set

A call center solution allows optimum distribution of calls to agents according to their availability and skills.

9.2 Open an agent session (login) – Agent set

- Select the ACD application.
- *Login*
- Select the agent and validate.
- **OK**
- Depending the displayed information, enter your password or confirm.

» ACD application welcome screen is displayed.

9.3 ACD application welcome screen – Agent set

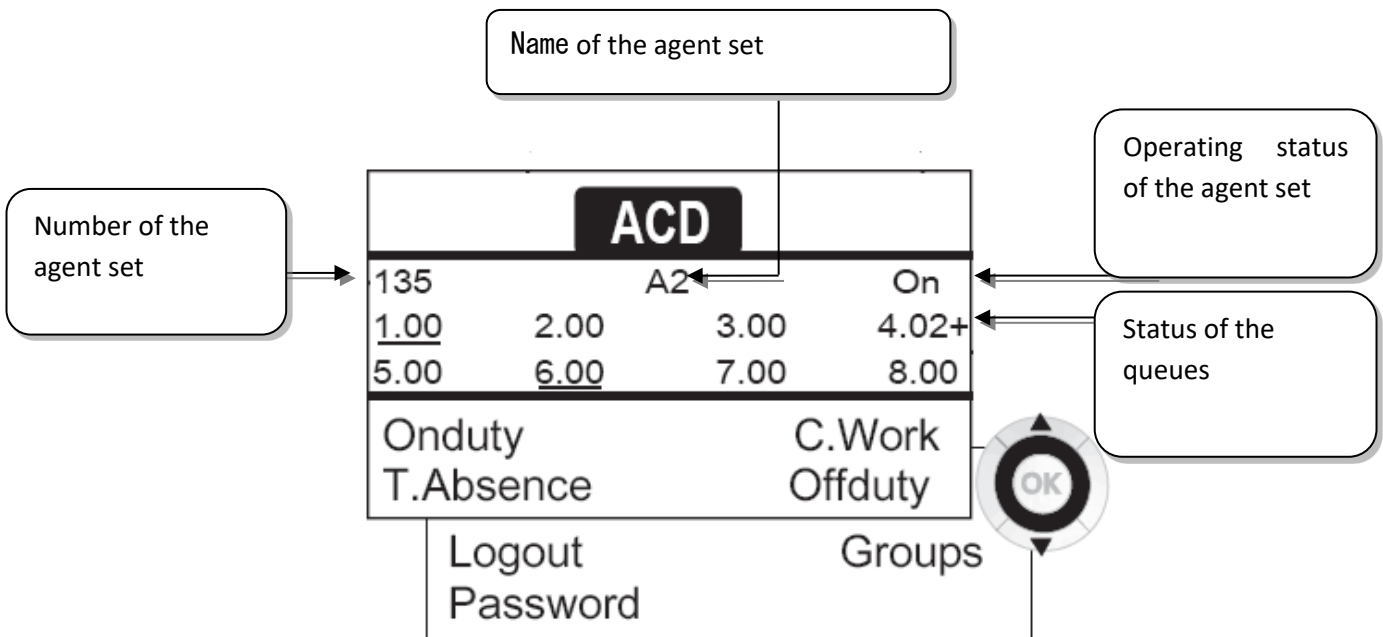

4.02 means: group number 4 / 2 calls waiting / the + sign indicates that the queue capacity has been reached .

9.4 The four operating statuses of the agent set

An agent's availability is determined by the operating status (of which there are 4), that the agent can change at any time. These statuses are:

- *Onduty* >> In service, the agent is ready to receive calls.
- *Offduty* >> Withdrawn, the agent has withdrawn from the ACD application.
- *C.Work* >> Additional task, the agent is performing a task concerning a call and is not taking other calls.
- *T.Absence* >> Temporarily absent, the agent has taken a break and is not taking calls.

The agent can change the operating status directly by entering codes, pressing the function keys, or using the Agent Assistant agent software on PC (if available).

9.5 Changing the operating status of the set – Agent set

9.5.1 Changing using codes (all sets)

The operating status change codes are defined when the system is configured. Contact the system administrator to obtain these codes.

- Enter the feature code to activate.

9.5.2 Change using function keys

- Press the function key of the status to be activated. Information relative to the selected status is displayed on the screen. If a refusal message is displayed, contact the system administrator.

9.6 Modifying your personal code – Agent set

- *Password*
- New code (6 digits).

9.7 Integrating another group/leaving a group – Agent set

- *Groups*
- Press the key of the group (1 to 8) to integrate (box empty) and/or press the key of the group to leave (box full).

9.8 Close the agent session (logout) – Agent set

- *Logout*

9.9 Supervisor station

- A supervisor can consult the messages left in the voicemail inboxes of the call center groups (maximum 8 groups) using the function keys.

A supervisor can also perform the agent function from the same set

9.10 Supervising group mailboxes – Supervisor station

9.10.1 Consulting the messages:-

When a message is left in a group mailbox, the voice mail present indicator associated with the supervision key flashes.

- Press the supervision key.
- Follow the instructions of the voice guide.

When a mailbox is consulted by a supervisor, the other supervisors cannot access it

9.10.2 Supervision keys for group mailboxes and positioning on the sets:-

- Access the Perso page to display the positioning of the supervision keys on the sets.

10 Accessories

The ALE-supported accessories are intended to work smoothly on most/all of our clients (hardphones, softphones). The list of accessories presented in this document is not contractually binding and may be modified without prior warning.

10.1 List of accessories

10.1.1 Jack 3.5 mm 4-pole corded headset

- Corded Premium Monaural Wideband Headset 3GV28047BA (Sennheiser SC 232)**. HD voice - Easy Disconnect - Cables Jack 3,5 mm, 4-pole and 3-pole
- Corded Premium Binaural Wideband Headset 3GV28048BA (Sennheiser SC 262)**. HD voice - Easy Disconnect - Cables Jack 3,5 mm, 4-pole and 3-pole
- Corded Monaural Wideband Headset 3GV28047AD (Plantronics HW510N)*. Quick Disconnect (QD) - Cables Jack 3,5 mm, 4-pole and 3-pole
- Corded Binaural Wideband Headset 3GV28048AD (Plantronics HW520N)*. Quick Disconnect (QD) - Cables Jack 3,5 mm, 4-pole and 3-pole
- Corded Monaural 3BN78815AB (Plantronics C215). Cables Jack 3,5 mm, 4-pole and 3-pole

*Compatible with 8008 DeskPhone with RJ9 adapter: QD RJ9 adaptater 3GV28177AA.

**Compatible with 8008 DeskPhone with RJ9 adapter (Sennheiser CSTD 01)



10.1.2 USB headset

- USB Binaural Headset 3GV28057AB (Plantronics C325-1).

10.1.3 Bluetooth® headset

- Bluetooth Monaural Headset 3BN67215WW (Plantronics Voyager Legend).

10.1.4 Adapter

- QD RJ9 adapter 3GV28177AA (box of 10 - Plantronics)
- 80XX JACK 4-3 POLE CABLE (box of 10) 3MG08018AA
- 80x8S SATA-RJ11 CABLE (box of 10) 3MG08019AA

10.1.5 Conference module

- Alcatel-Lucent 8125 Audiooffice usb.
- Alcatel-Lucent 8115 Audiooffice usb.

10.1.6 EHS interface

- External ringing interface module 3GV28050AA (MWS).
- USB external ringing interface module 3GV28184AA (USB Interface module 2 relays)

10.1.7 Other accessories (headsets)

Please consult the following sites of providers for compatible headsets:

- <https://www.plantronics.com/us/en/solutions/alcatel-lucent>
- <https://en-de.sennheiser.com/alcatel-lucent-headsets-unified-communications>
- <https://www.emea.jabra.com/business/for-your-platform/alcatel-lucent>

10.28115/8125 Audiooffice



	8078s BT	8078s	8068s BT	8068s	8058s	8028s	8018	8008
The accessory is supported by the following sets	●	●	●	●	●	●	●	

This section describes how to use the conference module 8115/8125 Audiooffice with your deskphone. For more information about 8115/8125 Audiooffice see the user manual of the device.

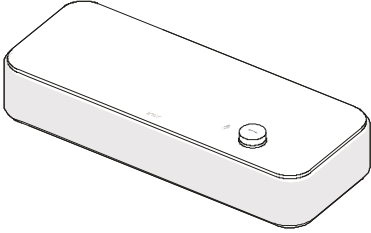
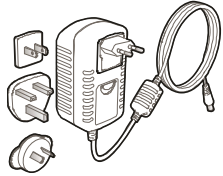
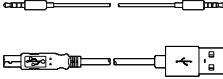
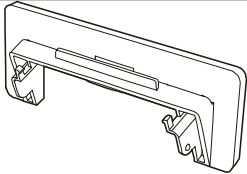
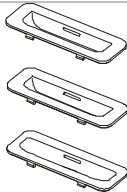
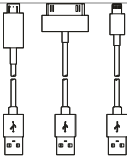
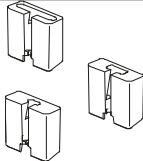
10.2.1 Box content

		8115 Audiooffice	8125 Audiooffice
Alcatel-Lucent 8115 Audiooffice base		●	
Alcatel-Lucent 8125 Audiooffice base			●
AC adapter		●	●
Jack 3.5 mm cable USB type A - type B cable		●	●
Tablet holder			●
Lightening, 30 pin and micro-USB adapters			●
Lightening, 30 pin and micro-USB cables			●
Lightening, 30 pin and micro-USB cable adapters			●

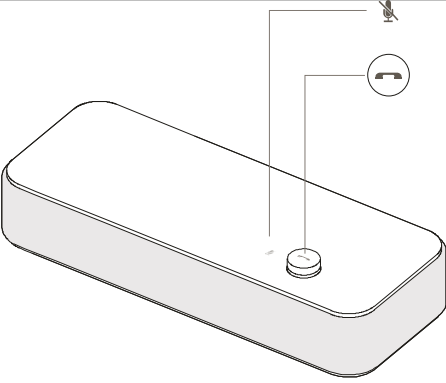
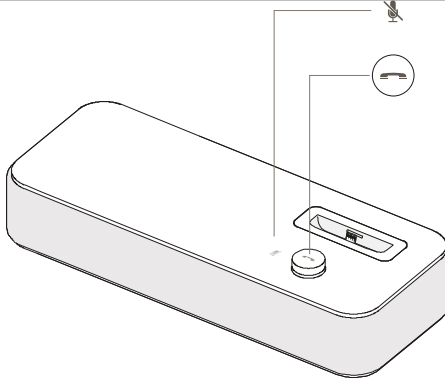
10.2.2 Description

8115 Audiooffice		8125 Audiooffice	
			
	Mute	Mute	
	Adjust volume. Receive and End a call.	Adjust volume. Receive and End a call. Bluetooth pairing.	

10.2.3 Set-up

Once installed, to benefit from the best sound quality avoid placing any objects (walls or cumbersome objects) within a range of 20cm.

1. Plug the mains power adapter into the back of the base and into a wall mount socket.

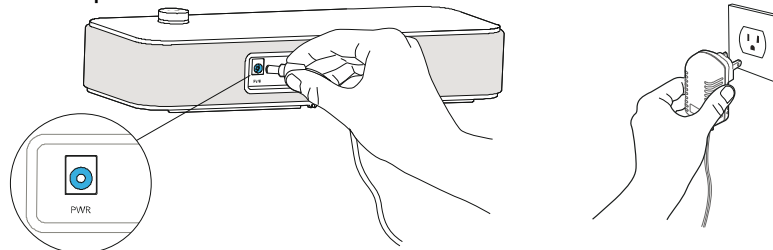

2. Press the On / Off button at the back of the base.

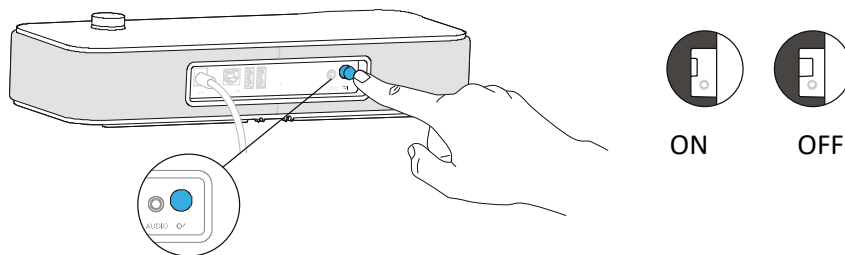

10.2.4 Connect your devices

8078s/8068s Bluetooth® Premium Deskphone

Connect the conference module 8125 Audiooffice to your deskphone via Bluetooth connection (see corresponding chapter of your deskphone and the conference module).

8078s Bluetooth®/8068s Bluetooth®/8078s/8068s/8058s/8028s Premium Deskphone

The conference module is equipped with a 3 pole jack. You have to use a 3 pole jack to 4 pole jack adapter to connect the conference module to your deskphone. Use the provided jack cable connected to the conference module and a 3 pole jack to 4 pole jack adapter connected to your deskphone.

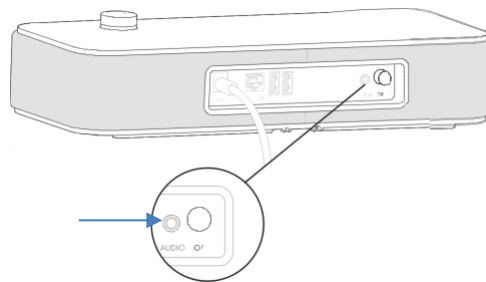

8018 DeskPhone

The USB slave port is to connect your deskphone to have the sound on the 8115/8125.

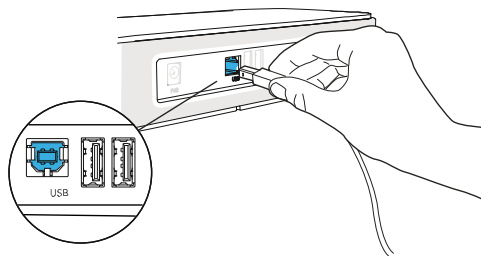

Other Devices

The 8115/8125 Audiooffice can be used to connect other device, like mobile phone (via Bluetooth, USB or Jack) or computer (Bluetooth, USB or Jack).

10.2.5 Bluetooth®(8125 Audiooffice)

The voice messages are in English until a first device is paired, the unit will then adopt the language of the Bluetooth device paired.

Long push the volume button until you hear a sound signal. A 'Pairing mode: waiting for connection' message allows you to pair your Alcatel-Lucent 8125 Audiooffice in your device Bluetooth menu. A final sound confirms the pairing.

Disconnect a paired device

Long push the volume button until hearing a double-sound signal. The last connected device is then disconnected and auto-connection is stopped. A 'Disconnecting' message and a sound signal confirm the disconnection.

Unpair all the connected devices

Long push the volume button until hearing a three-sound signal. A 'Clearing all subscriptions' message confirms it.

10.2.6 Use your device

Use the 8115/8125 Audiooffice as a conference module.

Placing or receiving an Alcatel-Lucent Deskphone call in jack mode

Upon jack connection to the Alcatel-Lucent Deskphone, user needs to configure the jack interface to 'External Handsfree' in order to use it for conference.

The jack connected, dial from your Alcatel-Lucent Deskphone and press the Alcatel-Lucent 8125 Audiooffice volume button to use it as a conference device.

To end the call, hang up the call from the phone.

Muting a call can be done with the Audiooffice Mute button or thru the Alcatel-Lucent Deskphone Mute key.

Placing or receiving an Alcatel-Lucent Deskphone call in Bluetooth mode (8125 Audiooffice)

Add the Alcatel-Lucent 8125 Audiooffice in the Alcatel-Lucent Deskphone Bluetooth device list with entering 0000 as a pin code.

Dial from your Alcatel-Lucent Deskphone and press the Alcatel-Lucent 8125 Audiooffice volume button to use it as a conference device.

To end the call, you can press the volume button again or hang up the call from the phone.

Muting a call can be done with the Audiooffice Mute button or thru the Alcatel-Lucent Deskphone Mute key.

Adjusting the volume

Turn the volume button to regulate the volume coming from the speakers.

Activating and deactivating the mute

Tap the Mute icon from your Alcatel-Lucent deskphone or directly from the Alcatel-Lucent 8125 Audiooffice icon.

Activating and deactivating the speakers

To accept a call in speaker mode or to switch to speaker mode during a call, press the volume button on the base.

10.2.7 Use the 8125 Audiooffice with your mobile

You can connect your mobile to the conference module by using the Lightning, 30 pin and micro-USB adapters. A Bluetooth® connection is needed to place and receive your mobile calls on the Alcatel-Lucent 8125 Audiooffice. To receive and end a voip call, use your Alcatel Lucent softphone application.

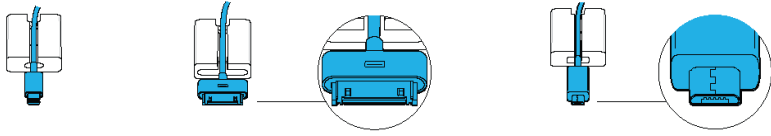
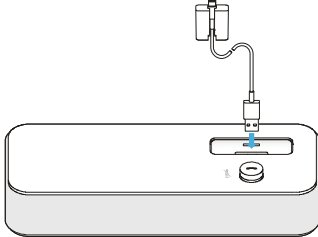
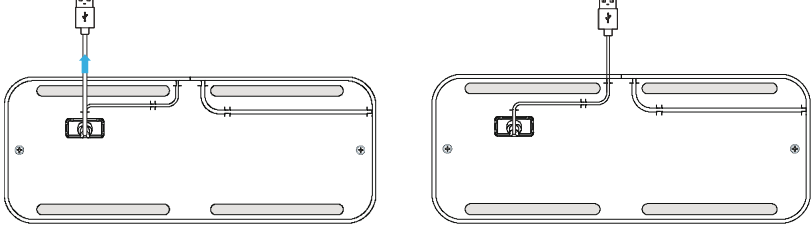
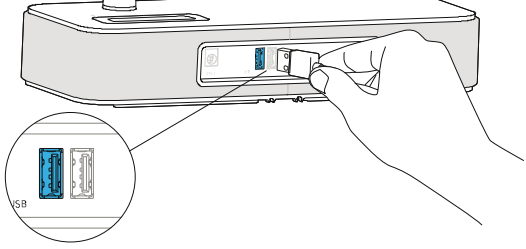
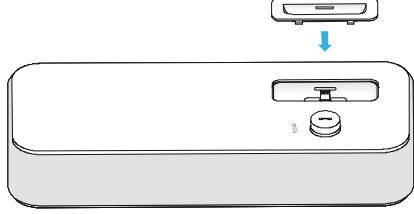
<p>Insert the cable suitable to your smartphone into the matching cable adapter. Place the cable in the cable hole.</p>	
<p>Slide the cord into place through the interstices under the base.</p>	
<p>Slide the cord into place through the interstices under the base.</p>	
<p>Plug the USB connector to the left USB port at the rear of the device.</p>	
<p>Insert the suitable adapter to your smartphone, or none if you use a case and your device doesn't fit.</p>	

10.3 USB external ringing interface module (USB Interface module 2 relays 3GV28184AA)

	8078s BT	8078s	8068s BT	8068s	8058s	8028s	8018	8008
The accessory is supported by the following sets	●	●	●	●	●	●		

The USB external ringing interface module allows driving an external system (like a ring or a lamp), following the ring tone cadence or the communication state of the phone connected on the telephone line. No system configuration is requested to install the module.

USB Interface module 2 relays lets to connect directly one or 2 external ringings on the USB connector of your deskphone:

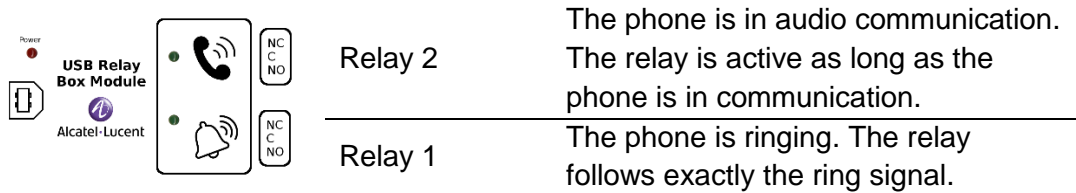

List of supplies

- USB external ringing interface module.
- 1 USB cable 1,5 m (4,9 feet) USB type A - USB type B.

10.3.1 Installation

WARNING: The module must be closed before use. No settings require the module to be open.

In idle state:

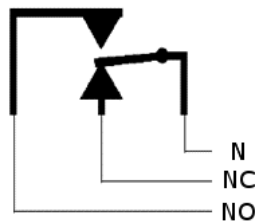

Ringing or during communication:

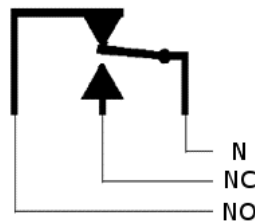

N: Common.
NC: active signal.
NO: non-active signal.

Typical usage diagram:

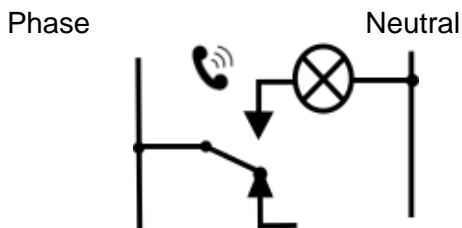

The lamp lights up when the phone is in communication.

The breaking capacity is 12V/24V DC 15A or 120V/220V AC at 10A.

10.3.2 Connect the device





- Plug the provided cord USB type B on the USB connector of the module.
- Plug the provided cord USB type A on the USB connector of the deskphone. See description of the connectors of your phone.

10.4 External ringing interface module (MWS 3GV28050AA)

	8078s BT	8078s	8068s BT	8068s	8058s	8028s	8018	8008
The accessory is supported by the following sets	●	●	●	●	●	●		

You have to use a RJ11 to SATA adapter to connect your deskphone to this device. The RJ11 to SATA adaptor is sold separately (3MG08019AA).

The external ringing interface module allows driving an external system (like a ring or a lamp), following the ring tone cadence of the phone set connected on the telephone line. A switch on the electronic board allows selecting between 2 operation modes.

-  Follows the cadence: the relay follows exactly the ring signal.
-  Hold mode: the relay is held for 0,7 s after the ring signal is gone. It erases some of the ring pulses.

10.4.1 List of supplies

- 1 external ringing interface module.
- 3 circuits plug to screw.
- 1 RJ11/RJ11 3 meters (10 feet) cable.
- 1 DC Japan/DC Japan 3 meters (10 feet) power cable.

A power supply may be required to power the module when used with IP phone powered remotely (Power Over Ethernet).

Use only the following power supply (Sold separately): 3MG27006xx

10.4.2 Installation

WARNING: The module must be closed before use. No settings require the module to be open.

In idle state:

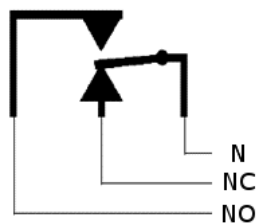



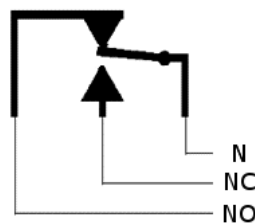

The phone is ringing:



N: Common.
NC: active signal.
NO: non-active signal.

10.4.3 Connect the device



Phone set connected over IP and to an external power supply		
1	Connected to the DC power jack of the deskphone by using DC Japan cable.	
2	Connected to the power supply of the device.	
3	Connected to the SATA connector of the deskphone, by using the RJ11 cable with an adpatator RJ11 to SATA. The RJ11 to SATA adaptator is sold separately.	 SATA
Phone set connected over IP and PoE		
1	Connected to the DC power jack of the deskphone by using DC Japan cable.	
2	Connected to the power supply of the device.	
3	Connected to the SATA connector of the deskphone, by using the RJ11 cable with an adpatator RJ11 to SATA. The RJ11 to SATA adaptator is sold separately.	 SATA

10.5 Wall mounting kit

10.5.1 8068s, 8058s, 8028s Premium DeskPhone

1

1. Rotate the metal foot to flat.
2. Remove the rubber cover on phone back shell each side.

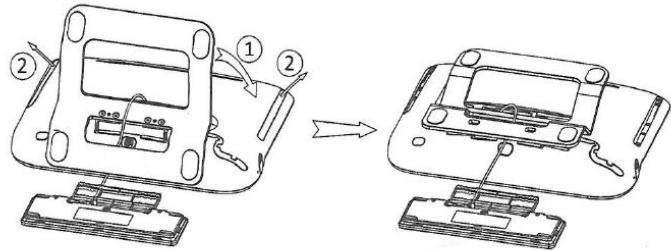

2

1. Drill two holes on the wall (separation=90mm, diameter=6mm).
2. Insert the fastener into the holes on wall (P/N: 1AD007550003).
3. Fix the support with both screws and adjust (P/N: 1AD007460003). The support is used as a reference and must be removeable.

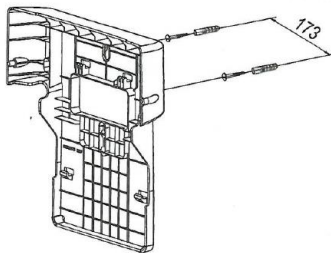

3

1. Put the support on the back side of the phone.
2. Slide it to top side and make sure the 4 hooks hold the metal foot.
3. Attach the magnetic alphabetic keyboard to the metal foot.
4. Push on the two corners of mini-keyboard to fix it in the support.

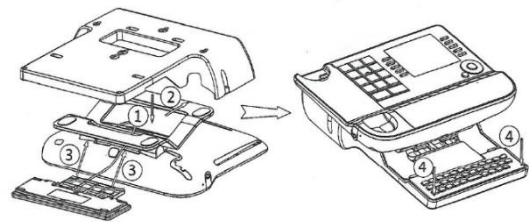

4

1. Fix the support with the phone by 1 screw (P/N: 1AD100020003).
2. Connect cables through the hole on support left side or right side.

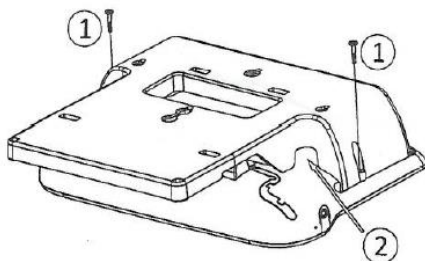

To connect ethernet, use RJ45 cable (P/N: 1AB045210162).

To connect the power, use extension cable (P/N: 1AB203010001).

5

1. Hang the assembled phone with support on the wall.

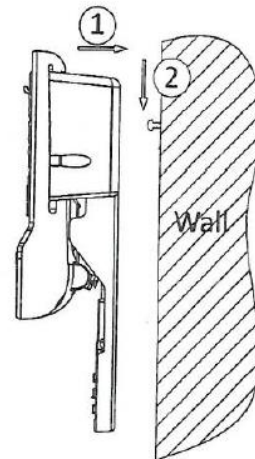

10.5.2 8018 DeskPhone

1

4. Drill two holes on the wall (separation=90mm, diameter=6mm).
5. Insert the fastener into the holes on wall (P/N: 1AD007550003).
6. Fix the support with both screws and adjust (P/N: 1 1AD007460003). The support is used as a reference and must be removeable.

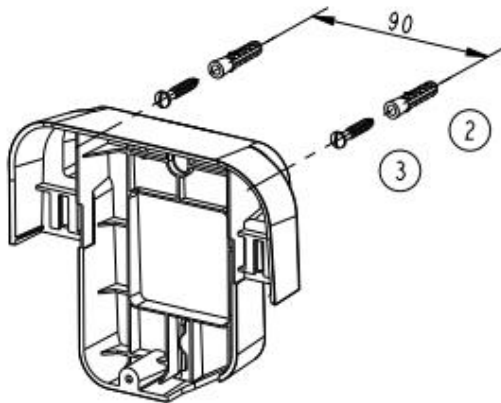

2

5. Put the support on the back side of the phone.
6. Slide it from top side and make sure the 2 snaps are engaged on the shell.

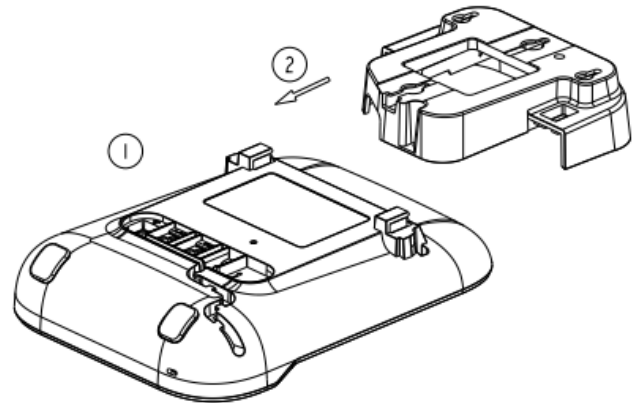

3

3. Fix the support with the phone by 1 screw (P/N: 1AD204430001).
4. Connect cables through the hole on support bottom side.

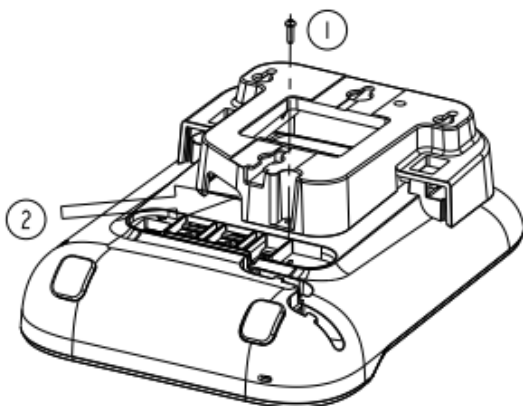

4

2. To connect ethernet, use RJ45 cable (P/N: 1AB045210162).

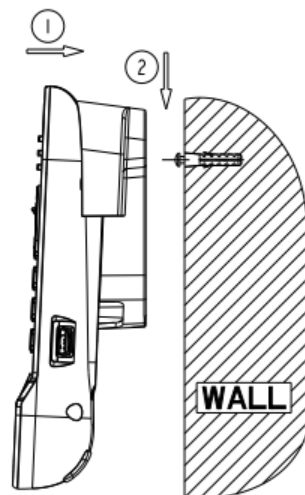

10.5.3 8008 DeskPhone

Installation of the wall mount kit

1

Fix the wall mount kit on the wall by using the 4 provided screws and nylon anchors. You can use the support as a reference to mark position. Remove it before drilling holes.

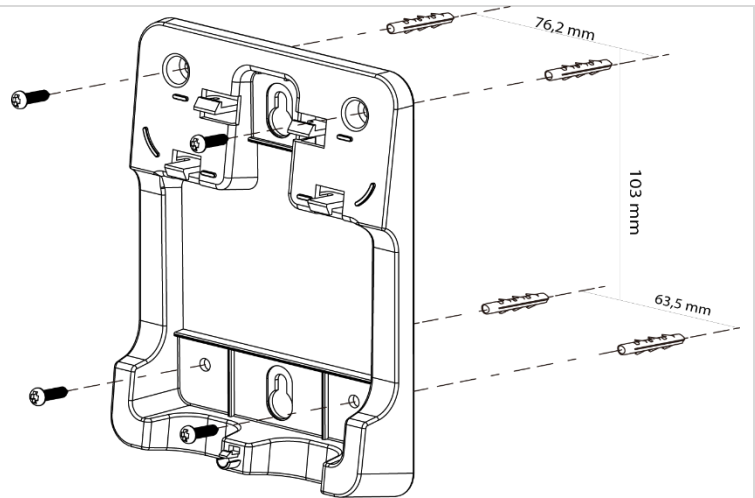

2

Assemble the phone with the wall mount kit by using the 5 hooks of the support.

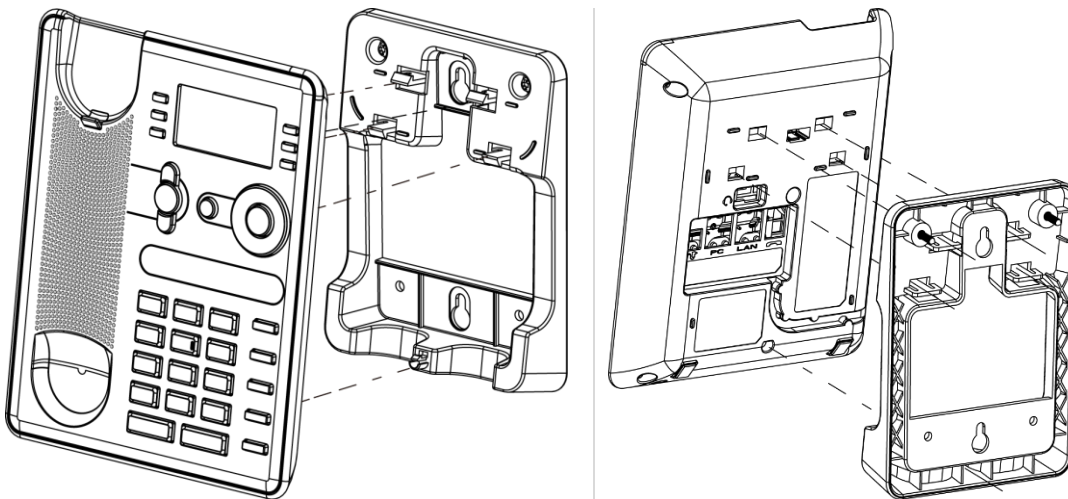

Pull out the phone from the support

1. Maintain the support with one hand by using the two holes on the bottom of the wall mount kit.
1. With the other hand, pull out the phone from the support as shown in the image.

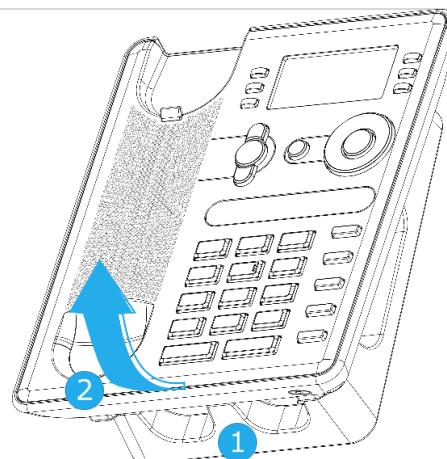

10.6 Connect a 3 pole jack headset

Your phone is equipped with a 3.5 mm, 4 pole jack. If your headset is not compatible (3 pole jack), you have to use adapters. Contact the manufacturer of your headset to find the appropriate adapter.

Use the following kit which contains a 3 pole to 4 pole jack adapter and a RJ11 to SATA adapter:

- 80XX JACK 4-3 POLE CABLE (box of 10) 3MG08018AA
- 80x8S SATA-RJ11 CABLE (box of 10) 3MG08019AA

1	A 3 pole to 4 pole jack adapter to connect the jack of the headset to the DeskPhone to manage audio
2	RJ11 to SATA adapter to connect the RJ11 connector of the headset to the SATA connector to the DeskPhone to manage ringing
3	EHS adapter (depends on your headset)

Example 1:

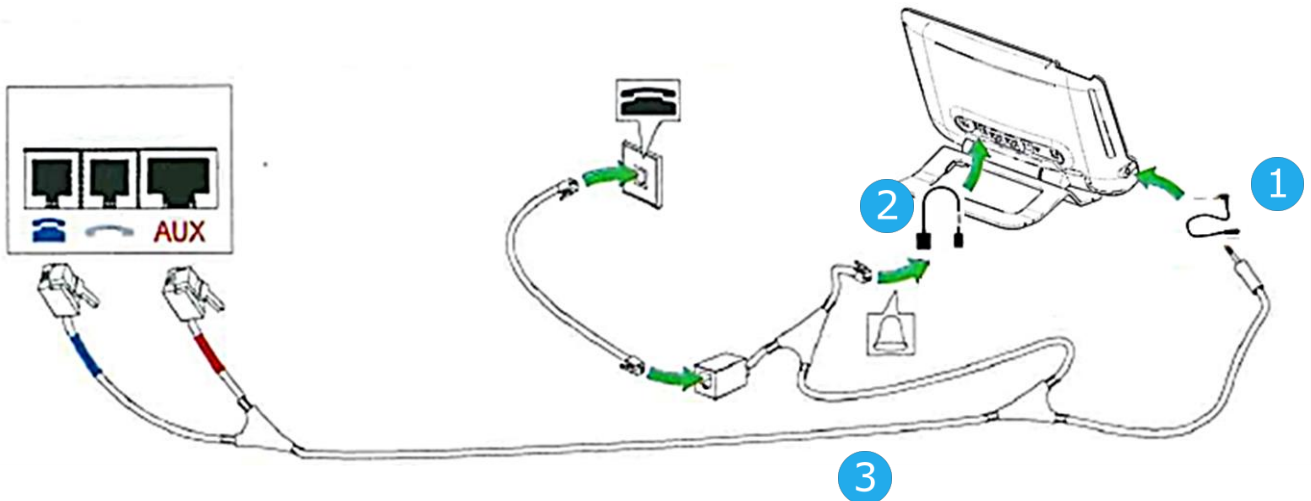

Example 2:

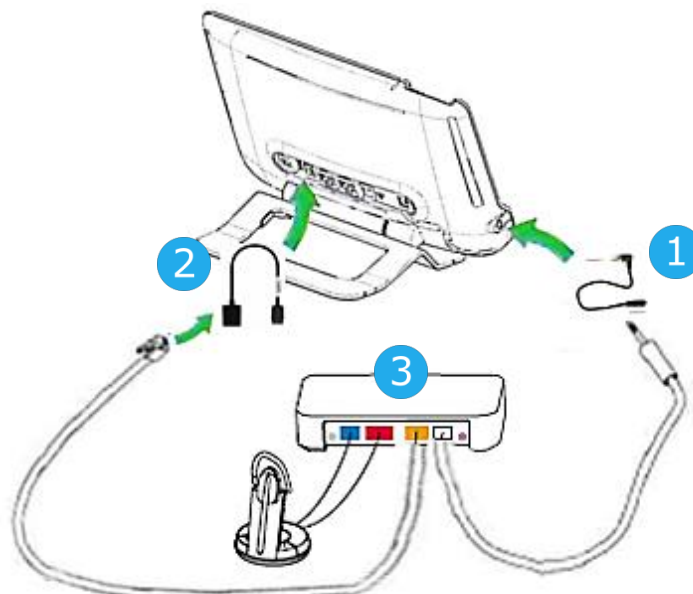

10.7 Alcatel-Lucent Enterprise Application Partner Program

The mission of the Alcatel-Lucent Enterprise Application Partner Program is to support a broad ecosystem of developers and partners throughout the deskphone Lifecycle. In this context, certification tests are made between applications or devices of partners and Alcatel-Lucent Enterprise's platforms. It certifies proper inter-working with applications or devices of the partner. Results of certification tests for headsets can be consulted in the Technical Document Library (restricted access, please contact your provider to access these documents).

- IWR-0121: Sennheiser Headsets / Desk phones <https://businessportal2.alcatel-lucent.com/IWR-0121>
- IWR-0018: Jabra Headsets for hardphones <https://businessportal2.alcatel-lucent.com/IWR-0018>
- IWR-0164: Plantronics-Headsets-Amplifiers <https://businessportal2.alcatel-lucent.com/IWR-0164>

11 Technical specifications

	8078s BT	8078s	8068s BT	8068s	8058s
Width	252 mm (9,92 in)	252 mm (9,92 in)	252 mm (9,92 in)	252 mm (9,92 in)	252 mm (9,92 in)
Depth on a table	200 mm (7,87 in)	200 mm (7,87 in)	200 mm (7,87 in)	200 mm (7,87 in)	200 mm (7,87 in)
Height	204 mm (8,03 in)	204 mm (8,03 in)	204 mm (8,03 in)	204 mm (8,03 in)	204 mm (8,03 in)
Weight	1450 g	1450 g	1350 g	1350 g	1350 g
Adjustable foot stand range	25° - 60°	25° - 60°	25° - 60°	25° - 60°	25° - 60°
Color	Moon grey	Moon grey	Moon grey	Moon grey	Moon grey
Display	5 inch capacitive touch color, 480 x 800 pixels, effective display area size 108.00 x 64.80 mm	5 inch capacitive touch color, 480 x 800 pixels, effective display area size 108.00 x 64.80 mm	3.5 inch color, 240 x 320 pixels, effective display area size 70.08 x 52.56 mm	3.5 inch color, 240 x 320 pixels, effective display area size 70.08 x 52.56 mm	3.5 inch color, 240 x 320 pixels, effective display area size 70.08 x 52.56 mm
Power over Ethernet (IEEE 802.3af)	Class 2	Class 2	Class 2	Class 2	Class 2
Power consumption (PoE) Idle – Active(w/o Add-on, w/o USB)	2.1 W – 3.5 W	1.9 W – 3.2 W	2 W - 3.1W	1.8 W - 2.8 W	1.6 W – 2.2 W
Operating conditions	-5°C - +45°C (23°F - 113°F)	-5°C - +45°C (23°F - 113°F)	-5°C - +45°C (23°F - 113°F)	-5°C - +45°C (23°F - 113°F)	-5°C - +45°C (23°F - 113°F)

	8028s	8018	8008
Width	252 mm (9,9 in)	164 mm (6.46 in)	150 mm (5,91 in)
Depth on a table	200 mm (7,87 in)	200 mm (7.87 in)	34,8 mm (1,37 in)
Height	204 mm (8,03 in)	170 mm (6.69 in)	195 mm (7,68 in)
Weight	1350 g (2.98 lbs)	675 g (1.48 lbs)	508 g (1,12 lbs)
Adjustable foot stand range	25° - 60°	45°	45°
Color	Moon grey	Black	Moon grey
Display	2.8 inch, 64 x 128 pixels black & white, white backlight, effective display area size 64 x 32 mm	2.4 inches 128 x 64 pixels graphic black/white LCD display, effective display area size 54.8 x 28.5 mm (2.15 x 1.12 in)	2.4 inches 128 x 64 pixels graphic black/white LCD display, effective display area size 52 x 26 mm (2.05 x 1.02 in)
Power over Ethernet (IEEE 802.3af)	Class 1	Class 1	Class 1
Power consumption (PoE) Idle – Active(w/o Add-on, w/o USB)	1.5 W – 2 W		Power supply: Optional accessory
Operating conditions	-5°C - +45°C (23°F - 113°F)	-5°C - +45°C (23°F - 113°F)	-5°C - +45°C (23°F - 113°F)

	External ringing interface module (MWS 3GV28050AA)	USB external ringing interface module (3GV28184AA)	8115 Audiooffice	8125 Audiooffice
Maximum distance between the phone set and the device	3 m (10 feet)	1,5 m (5 feet)		
Width	124 mm (1,2 in)	100 mm (3,9 in)	290 mm (11,4 in)	290 mm (11,4 in)
Depth on a table	130 mm (5 in)	62 mm (2,4 in)	114 mm (4,5 in)	114 mm (4,5 in)
Height	30 mm (1,2 in)	26 mm (1 in)	53 mm (2,1 in)	53 mm (2,1 in)
Weight	170 g		1497g (3,3 lbs)	1497g (3,3 lbs)
Adjustable foot stand range				
Color	Black and silver		Black	Black
Power consumption	500 mW			
Power consumption	2A 220 Vdc 250 Vac	15A 12/24Vdc 10A 120/220Vac	100-240V / 12V 3A AC	100-240V / 12V 3A AC
UL/CSA Ratings	<ul style="list-style-type: none"> • 30 Vdc / 2 A • 220 Vdc / 0.27 A • 120 Vdc / 0.5 A • 250 Vac / 0.25 A 			
Operating conditions			0°C – 40°C (32 °F - 104 °F)	0°C – 40°C (32 °F - 104 °F)

12 Ordering information

8008 DeskPhone	3MG08010AA
8008 Wall mounting kit	3MG02013AA
8008 Power adaptor	3MG08011AA
QD RJ9 adapter	3GV28177AA
8018 DeskPhone	3MG27201AA
8018 Wall mounting kit	3MG27210AA
8018 Customizable clip (x10)	3MG27211AA
8018 Noe paper label cover (x10)	3MG27212AA
8018 Us noe paper label cover (x10)	3MG27213AA
8018 Paper label (x64)	3MG27215AA
8018 Plastic foot (x10)	3MG27216AA
8028s Premium Deskphone	3MG27202xx
8058s Premium Deskphone	3MG27203xx
8068s Premium Deskphone	3MG27204xx
8078s Premium Deskphone	3MG27205xx
8068s Premium Deskphone BT	3MG27206xx
8078s Premium Deskphone BT	3MG27207xx
8028/8029 paper labels (x50)	3MG27114AA
Premium Add-on 10 keys module	3MG27105AC
Premium Add on 10 key modules paper labels (x64)	3MG27115AA
Premium Smart displays 14 keys module with clip	3MG27107AC
Premium Add-on 40 keys module with clip	3MG27106AC
Premium Add-on 40 keys module paper labels (x50)	3MG27116AA
80XX JACK 4-3 POLE CABLE (x10)	3MG08018AA
80x8S SATA-RJ11 CABLE (x10)	3MG08019AA
Wide Band Comfort Handset	3MG27032AA
Wide Band Bluetooth Handset	3MG27209AA
Magnetic Alphabetic Keyboard	3MG27208xx
Premium Wall Mounting Kit	3MG27110AA
Monaural Headset	3GV28047xx
Binaural Headset	3GV28048xx
Bluetooth Headset	3BN67215WW
Binaural USB Headset	3GV28057xx
AC/DC Power Adapter (100–240 V AC/48 V DC)	3MG27006xx
Conference Module 8115 Audiooffice	3MG08001AA
Conference Module 8125 Audiooffice	3MG08002AA
External ringing interface module without PSU	3GV28050AA
USB external ringing interface module	3GV28184AA

13 Guarantee and clauses

Current Safety and Regulatory Statements relate to the 8008, 8018 DeskPhone and 8028s, 8058s, 8268s, 8078s Premium DeskPhone sets only, and do not apply to accessories.

13.1 Safety Instructions

- Changes or modifications to the equipment not expressly approved by the party responsible for compliance could void the user's authority to operate the equipment.
- Magnets could affect the functioning of pacemakers and implanted heart defibrillators. Keep a safe distance between your pacemaker or implant defibrillator and the handset which includes magnetic elements: 4 centimeters (1,6 inches) at least.
- To limit the risk of interference, people with pacemakers must keep the wireless telephone away from their equipment (minimum distance of 15 cm/6 inches).
- It is recommended to follow the standard acceptance procedures before using this equipment in human safety critical areas (hospitals...).
- The handset includes magnetic elements that may attract sharp metallic objects. To prevent injury, before each use ensure sharp metallic objects are not stuck to the earpiece and microphone.
- A Bluetooth® Handset with integrated battery is available with certain Product variants. The battery must be charged during 6 hours before initial use and must be replaced correctly to prevent danger of explosion. Use only the recommended battery. Contact your Business Partner if you need a spare battery.
- Avoid using phones (other than cordless type) during an electrical storm. There may be a remote risk of electric shock from lightning.
- Do not use the device in environments where there is a danger of explosion.
- Do not plug this phone into an Integrated Services Digital Network (ISDN) connection or into a regular Public Switched Telephone Network (PSTN) connection. This can result in severe damage to the phone.
- Never allow your telephone to come into contact with water.
- To clean your telephone, use a soft damp cloth. Never use solvents (trichlorethylene, acetone, etc.) which may damage the plastic parts of your telephone. Do not use aerosol cleaners.
- this product is intended to be supplied, either via the Ethernet (LAN) port, or via the DC-in by a Certified Direct Plug-In Power Unit approved as 'LPS' (Limited Power Source) against CSA/UL/IEC 60950-1 and rated 48V dc, minimum 0.27A. Allowed power supplies: WA-13B48R – Asian Power Devices Inc.
- Some Premium DeskPhones and Smart DeskPhones also offer a Bluetooth® radio interface for Bluetooth® handsets or other Bluetooth® devices frequency range 2402-2480 MHz, radiated power 5 mW.
- If you are connected to a POE connection do not use an external Power Supply.
- The cover of the phone screen is made of glass. This glass could break if the phone is dropped or it receives a significant blow. If the glass chips or cracks, stop using the phone and do not touch the broken glass as this could cause injury to you. Glass cracked due to misuse or abuse is not covered under the warranty

13.2 Regulatory Statements

EUROPE

This equipment complies with the essential requirements of following directives: 2014/53/EU (RED), 2014/30/EU (EMC), 2014/35/EU (LVD), 2009/125/EC (ErP), 2011/65/EU (RoHS).

Declaration of Conformity may be obtained from:

ALE International 32 avenue Kléber – 92700 Colombes, France
ebg_global_supportcenter@al-enterprise.com

USA and Canada

Phones with Bluetooth® comply with Industry Canada's license-exempt RSSs. Operation is subject to the following two conditions: (1) this device may not cause harmful interference, and (2) this device must accept any interference received, including interference that may cause undesired operation. This equipment has been tested and found to comply with the limits for a class B digital device, pursuant to Part 15 of the FCC Rules. These limits are designed to provide reasonable protection against harmful interference in a residential installation. This equipment generates, uses and can radiate radio frequency energy and, if not installed and used in accordance with the instructions, may cause harmful interference to radio communications. However, there is no guarantee that interference will not occur in a particular installation. If this equipment does cause harmful interference to radio or television reception, which can be determined by turning the equipment off and on, the user is encouraged to try correcting the interference by consulting the dealer.

Exposure to Radio Frequency Signals

This equipment complies with radiation exposure limits set by FCC/IC and the Council of European Union for an uncontrolled environment. This equipment has very low levels of RF energy and is deemed to be compliant without testing of the specific absorption rate (SAR).

User Instructions

Use this product in temperatures between -5°C to +45°C (23°F to 113°F).

This product is intended for use in an indoor environment only. This apparatus is Hearing Aid Compatible (HAC).

Acoustic shock protection

Maximum sound pressure level for handset is compliant with European, US and Australian standards.

Directive 2003/10/EC specifying the risks inherent in noise at work

The ring contributes towards overall daily noise - at its maximum setting, the level is 105 dBA at 60 cm from terminal. To reduce the level, the following is recommended:- reduce the setting (9 levels of 5 dB) - program a progressive ring.

Privacy

Privacy of communications may not be ensured when using the Bluetooth® handset or any additional Bluetooth® device.



Disposal

The equipment must be returned to a collection point for electronic equipment waste disposal. Defective batteries must be returned to a collection point for chemical waste disposal.

Related Documentation

Other languages for these Safety and Regulatory Instructions and User Documentation are available at the following Web site:

<https://www.al-enterprise.com/products>.







The Alcatel-Lucent name and logo are trademarks of Nokia used under license by ALE. To view other trademarks used by affiliated companies of ALE Holding, visit:









www.al-enterprise.com/en/legal/trademarks-copyright. All other trademarks are the property of their respective owners. The information presented is subject to change without notice. Neither ALE Holding nor any of its affiliates assumes any responsibility for inaccuracies contained herein.





© 2018 ALE International. www.al-enterprise.com.

Features keys	
Mute and interphony.	
Hands-free, handset or headset volume. Adjust the brightness (8078s, 8068s, 8058s). Adjust contrast (8028s, 8018).	
Audio services (hands-free, handset or headset).	
<ul style="list-style-type: none"> Programmable keys (F1 and F2 keys): Lit when the function associated with the key is activated. A service or a direct call can be associated to these keys. Pre-programmed function keys are disabled in 'safe' mode. The F1 and F2 keys are line keys. 	
Redial key: to access the 'Redial' feature. For the 8018 DeskPhone, the redial key is associated with the Off-hook key when the phone is in idle state: .	
Quick access to user local menu (long press). Used to obtain information on functions of the 'menu' page and to program key of the 'perso' page (short press). Not available on 8018/8008 DeskPhone.	
Messaging key to access various mail services. This key is lit when you have received a new voicemail, text message or callback request.	
Hands-free key To make or answer a call without lifting the handset.	
END key To terminate a call.	
Bluetooth® wireless handset (Compatible Bluetooth® deskphone)	
Off-hook/On-hook.	
Volume/Mute: <ul style="list-style-type: none"> Short successive presses to change the handset volume level (3 levels). Long press to ensure your caller no longer hears you. 	
Welcome screens	
<p>You can access all of your phone's features from these screens. The default display has three pages that you can access by pressing to the page tabs at the top of the screen. The selected page is highlighted.</p> <ul style="list-style-type: none"> Menu page Contains all functions and applications accessible via the keys associated with the words on the screen. Perso page Contains call line keys (allowing supervision of calls) and programmable call keys. Info page Contains information on the telephone and the status of its functions: name, telephone number, number of messages, activation of transfer function, appointment reminder, etc. 	
	Manage your call forwarding by pressing the forward icon. <ul style="list-style-type: none"> Stationary arrow: No forwarding activated. Blinking or rotating arrow according to the skin: Forwarding activated.
Touchscreen navigation (8078s/8078s BT Premium DeskPhone)	
	Select a page by pressing the corresponding tab on the screen. The selected page is highlighted. Make your selection by pressing the label on the screen.
	Scroll through a list (features, call log, contact, ...) by pressing the up and down arrow on the screen, or the up-down navigator keys.
	Use the 'OK' softkey to validate your choices and options while programming or configuring.

	Use the 'Back/Exit' icon to go back to the previous step.		
	Use the 'Setting' icon for quick access to the user local menu.		
	Use the 'Bluetooth®' icon to open Bluetooth® settings.		
Navigation keys			
	<ul style="list-style-type: none"> OK key: Use this key to validate your choices and options while programming or configuring. Left-right navigator: Used to move from one page to another and display information about current calls (call in progress, calls on hold, incoming call). Up-down navigator: Used to scroll through the content of a page. 		
	<ul style="list-style-type: none"> Use this key to go back to the previous step. Use this key to go back to the homepage (long press). 		
Status icons/ Call icons			
	Silent mode.		Incoming call icon.
	Telephone locked.		Call in progress icon.
	Headset connected/Handsfree connected		Call holding icon.
	Appointment programmed.		Your contact ended the conversation.
Magnetic alphabetic keyboard		User local menu	
Cursor moving keys (left, right, up and down).		or (long press): Open the user local menu. The user local menu depends on the type of the set. The user local menu lets you: <ul style="list-style-type: none"> Configuring the audio jack of your telephone. Adjusting the brightness of the deskphone. Activate/deactivate the logo on back shell. Installing a Bluetooth® Wireless accessory. Display all paired Bluetooth® devices. Removing a Bluetooth® accessory (headset, handset, etc.). Use your DeskPhone as a Bluetooth® audio accessory. Change the theme (skin) of your phone. 	
Caps lock: to write text in capital letters.			
Alt key: to access specific and punctuation characters.			
Enter key: to validate edited text.			
Backspace key: to delete one character in an edit box.			
Alpha-numeric keyboard (8018/8008 DeskPhone)			
<ul style="list-style-type: none"> 123<>abc: Switch the keyboard to the alphabetic mode by selecting the associated preprogrammed key. When activated, the LED corresponding to the key remains lit up. Enter alphabetic characters. The number pad keys have letters that you can display by successive presses. The number is the last character in the series. Some special characters can be displayed by successively pressing the key: 			
	%	\$	/ ~ & () [] = *
	@	#	
	space		- _ 1
	+	.	, ; : / ? ! < > 0

Call Dial the number directly or dial the number after pressing a line key (an off-hook key phone or Bluetooth® handset, hands-free key).	
Call by name (Company directory) Enter the first letters of contact's name and follow the on-screen instructions.	
Answer a call Take the handset off the hook, use an off-hook key (phone or Bluetooth® handset), use the hands-free key, or press the incoming call icon.	
Ignore call / End the call.	
Redial Long press to access the list of the last 10 dialed numbers. Short press to call the last dialed number.	
Make a call-back request to a busy number <i>Callback</i>	
Placing a call on hold (hold) <i>Hold</i>	
Sending DTMF signals <i>MFcode</i> Send numbers.	
Mute	
Interphony The phone automatically answers the call. Before the line is taken, you hear a succession of specific beeps.	
Making a second call during a conversation <i>New call</i>	
Answering a second call during a conversation. Select the incoming call icon.	

Switching between calls (Broker call) Select the call on hold icon from the conversation screen.	
Cancel your second call You automatically recover the first call.	
Transferring a call You are in conversation with one contact. Call a second contact. <i>Transfer</i>	
Conference Call the first contact. Call the second contact. <i>Conference (Conf)</i>	
Make calls via your programmed call keys Press the desired programmed call key.	Perso
Programming direct call keys Press the 'I' key or <i>Settings > Keys</i> Select the key to program. Enter the name and number to associate to the key.	Menu 
Modify the programmed key Press the 'I' key or <i>Settings > Keys</i> Press the programmed key to be modified. Follow the on-screen instructions.	Menu 
Erase a programmed key Press the 'I' key or <i>Settings > Keys</i> Select the key to be erased. Follow the on-screen instructions.	Menu 
Customizing your voice greeting <i>Settings > Mailbox</i> You can listen to the greeting, customize the greeting and set the default greeting.	Menu
Consulting your voice mailbox	
Diverting calls to your voice mailbox Select the forward icon. <i>Immediate VM</i> Select the type of call forwarding required.	
Cancel forward Select the forward icon. <i>Cancefwd.</i>	

Do not disturb Select the forward icon. <i>DoNotDisturb (DND)</i>	
Send text messages <i>Message</i> <i>SendTxtMsg</i> Enter the destination number. Select the type of message to send (fixed Msg, New Msg,...).	
Read text messages <i>Message</i> <i>ReadTxtMsg</i>	
Information about the phone	Info
Lock/unlock the phone <i>Lock</i>	Menu
Adjust audio volume	
Select the language of your choice <i>Settings > Options > Language</i>	Menu
Choose the tune <i>Settings > Phone > Ringing</i> Adjust the ring via the following menus: Melody, Silent, Beeps, Volume, etc.	Menu
Adjust the brightness of the set Press the 'I' key <i>> Display > Brightness</i>	
Modify the password for your phone set <i>Settings > Options > Password</i>	Menu
Homepage <i>Settings > Options > Homepage</i> Select the default page.	Menu